

Programmable Synthetic Hallucinations: Towards a Boundless Mixed Reality

by Daniel Edward Novy

S.M., Media Arts and Sciences, Massachusetts Institute of Technology (2013)

M.A., Theater History, University of Illinois—Urbana-Champaign (1995)

B.F.A., Theater, University of Illinois—Urbana-Champaign (1993)

Submitted to the Program in Media Arts and Sciences, School of Architecture and Planning, in partial fulfillment of the requirements for the degree of Doctor of Philosophy in Media Arts and Sciences at the Massachusetts Institute of Technology, June 2019

©Massachusetts Institute of Technology. All rights reserved.

Signature redacted

Signature of Author: _____

✓
Daniel Edward Novy
Program in Media Arts and Sciences
Massachusetts Institute of Technology
February 22, 2019

Signature redacted

Certified by: _____

✓
V. Michael Bove, Jr., Ph.D.
Principal Research Scientist, Media Laboratory
Massachusetts Institute of Technology

Signature redacted

Accepted by: _____

✓
Tod Machover
Academic Head, Program in Media Arts and Sciences

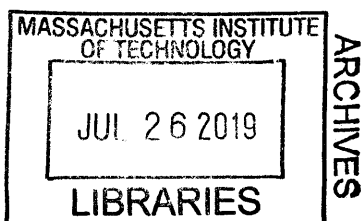

PROGRAMMABLE SYNTHETIC HALLUCINATIONS: TOWARDS A BOUNDLESS MIXED REALITY

by

Daniel Edward Novy

Submitted to the Program In Media Arts And Sciences,
School of Architecture and Planning, on February 22, 2019
in partial fulfillment of the requirements for the degree of
Doctor of Philosophy in Media Arts and Sciences

Abstract

Programmable Synthetic Hallucinations describe the utilization of the bio-physiological mechanics of hallucination generated in the human brain to display virtual information directly in the visual field. Science fiction films, television shows, and video games have trained audiences to think of holograms as luminous volumetric images that float registered in the viewer's 3D space and require no special glasses or optics to see or interact with them.

The ability of users to interact with a floating aerial lightfield without the use of face-worn binocular optics is a difficult challenge and one in which a hallucinatory experience offers a solution. While we do not have the ability to activate individual neurons to recreate a neuro-electrical pattern indiscernible from the perception of reality, this dissertation shows that creating phosphenes within the visual field via the magnetic stimulation of neurons in the visual cortex is a viable first step. By electrically stimulating the cells in the hypercolumns of V1, one can induce the perception of a pixel of light within the visual field of a user. These magnetophosphenes are visual perceptions described as luminous shapes, which can be created by time-varying magnetic fields. These change the membrane potential and trigger an action potential directly in neurons of the visual cortex.

Previous TMS studies have shown evocation of phosphenes in a binary manner, with subjects reporting the presence or absence of a phosphene but not targeted to a specific location. However, to date, no information or example has been found indicating the use of cortical phosphenes, induced magnetically or otherwise, in performance or public display.

Presently, commercial transcranial magnetic stimulators can only be focused to an area approaching one square centimeter, a single output channel, and require manual placement of the coil apparatus. Novel coil designs became a central focus of this research. Further work increased the number of output channels, embedding them in a wearable apparatus with a multichannel array of induction coils. Clinical trials were undertaken at MIT's Clinical Research Center. We were able to evoke visual phenomena in 11 out of 16 test subjects in a known, targeted location. The induced magnetophosphenes were noted above the noise floor of naturally

occurring retinal phosphenes and were statistically verified to be a result of the system being tested.

Thesis supervisor: V. Michael Bove

Title: Principal Research Scientist, Media Laboratory

This doctoral thesis has been examined by a Committee as follows:

Signature redacted

V. Michael Bove, Jr., Ph.D.....

.....
Thesis Supervisor
Principal Research Scientist, Media Laboratory
Massachusetts Institute of Technology

Signature redacted

Ed Boyden, Ph.D.....

.....
Reader, Thesis Committee
Associate Professor, Media Lab and McGovern Institute
Departments of Biological Engineering and Brain and Cognitive Sciences
Co-Director, MIT Center for Neurobiological Engineering
Massachusetts Institute of Technology

Signature redacted

Joe Paradiso, Ph.D.....

.....
Reader, Thesis Committee
Alexander W. Dreyfoos (1954) Professor in Media Arts and Sciences
Massachusetts Institute of Technology

ACKNOWLEDGEMENTS

I owe everything to the following people without whom I would never have believed what I accomplished to be possible.

To my adviser, Mike Bove, for taking a risk on an old dog and having the courage to teach him new tricks. Your mentorship, experience, and the joy and passion with which you approach each new student and each new semester is infectious and I hope we can walk, sail, or fly many more miles together. Your patience with my disnumeracy is noted.

To my thesis committee, Joe P and Ed Boyden, out of whose classes this science fictional concept of neuro-engineering hallucinations was literally born. Some ideas seem crazy, even for the Media Lab, and I appreciate that you've always thought this endeavor was even remotely possible.

To Kristin, Buffy, and Skyler, for keeping our group operational despite financial constraints, and for keeping me sane with well-timed visits. Your belief in, and patience with, me kept me going even when I saw very few ways forward.

To the OBMG members and rescued crew mates, past and present; James B, Dan Smalley, Bardagjy, Santiago, Edwina, Sunny, Laura, Pip, Everett, Bianca, Pedro, Ali, Vik, Caroline, Nick S, Emily S, Nina, and UROPs and MEngs past, EVB and Kristin Z. Our crew is motley, but the best crews are made strong and agile by their differences. I am proud to have served with you all.

To Linda, Keira (please come back), and the crew in the MAS office, for eons of patience.

To Bryan Mayton, without whom I would still be plugging things in and trying them until they blew up. There will always be single malt at my desk for you and thanks for all the spare parts.

To Neil G, Tom, John D, and the rest of the crew in CBA. How To Make changed my life and affirmed my future. Literally none of this would've been built without your guidance and generosity of knowledge and machine time.

To Katy Croff Bell, for believing in me enough to provide financial support and your deep appreciation of rum, shenanigans, and the future.

To Mark Feldmeier and Nathan Lachenmyer, who knew exactly how dangerous what I was attempting was but never shied away from helping me.

To the fine nursing staff at MIT's Clinical Research Center; Catherine Ricci, Tatiana, and O'Mara, for keeping my subjects safe, for keeping me from losing it when things were melting down, and for insisting I keep all my fingers.

Special thanks to the Epilog corporation for making a laser cutter I can play like a Stradivarius, regardless of all its strange little quirks.

To Rahul B for his box maker; without you, all my projects would still be laying out on the bench right now.

To Joost, for every late-night talk at the Muddy, for every idea, for every “Spinonym,” and for your natural way of seeing all possible roads and outcomes of a project, even when I couldn’t. Some of us at the Media Lab know how valuable you are and will always have your back.

To Holly and Amna; Queens of the Calendars, full of joy, encouragement, and support.

To Chong Lee, nomadic office-mate, for making me do the math.

Kongo and the 99Fridays Crew, sometimes you need to go a little crazy just to keep from going mad.

To Andy Lippman and Hiroshi Ishii, for your continued interest in my work and your rigor to make it better.

To Mirei Rioux, for all the trips to Japan. Let’s hope there are many more.

To Kevin Slavin, who grok’ed me immediately and who taught me sometimes causing friction is good and that efficiency shouldn’t always be the goal. Playful Systems never died.

To my past but always very-much-in-mind partner-in-crime, Janice Wang. Someday, a food lab!

To William Gibson, Ramez Naam, Philip K. Dick, and Neal Stephenson, without whom there would have been no idea to make into this reality.

To Ursula K. Le Guin, for showing me how to see the OMELAS all around and how to walk away if needed.

To the Boston Burning Man Community for your undying support no matter how much time passes between seeing each other. I promise more Tuesdays at the CBC.

The Internet coil gun and Tesla coil community, for making tools without which I would still be sinking.

To my parents, who were utterly baffled that I would throw away what they felt was a perfectly respectable, successful career in Hollywood to go and do strange things with electricity in Boston. I’m still not sure they understand what I do but they support me none the less.

To my daughter, Connor Kelly Novy, the bright-star of my life and all my pride and joy, I’m so grateful we were able to go to college together and that we’ve both found a home and family in Boston. And to my new son-in-law, Joel, welcome to the Novy show.

And of course, to say that I would be alive, sane, in one piece, and finished without my spouse, my love, my life, Chia Evers, would be to tell a lie so ponderous, the universe would collapse from the sheer weight of its gravity. There would be no me without you. I think maybe you were right. Maybe I should apply to the Media Lab.

And finally, to Joi Ito, who took me under his wing shortly after we both arrived at the Media Lab and who has shown me a bigger faith, hope, community, and family. I look forward to years of crafting more of these together for the Media Lab and for as long as you call me friend.

“Cyberspace. A consensual hallucination experienced daily by billions of legitimate operators, in every nation, by children being taught mathematical concepts...A graphic representation of data abstracted from banks of every computer in the human system. Unthinkable complexity. Lines of light ranged in the nonspace of the mind, clusters and constellations of data. Like city lights, receding...”—William Gibson, *Neuromancer*

TABLE OF CONTENTS

<i>Abstract</i>	2
<i>Acknowledgements</i>	5
<i>Table of Contents</i>	8
<i>Chapter 1: Introduction</i>	14
<i>Chapter 2: Background and Prior Art</i>	22
<i>Chapter 3: Implementation</i>	39
<i>Chapter 4: Clinical Trials</i>	85
<i>Chapter 5: Results and Discussion</i>	99
<i>Chapter 6: Contributions and Conclusions</i>	105
<i>Chapter 7: Future Vision</i>	109
<i>References</i>	118
<i>Author Biography</i>	123
<i>List of Figures</i>	124
<i>Appendix</i>	126

“Fiction is an illusion wrought with many small, conventionally symbolic marks, triggering visions in the minds of others.”—William Gibson

CHAPTER 1: INTRODUCTION

By the time William Gibson coined the term “cyberspace” in 1984 with the release of *Neuromancer*, over a century of preceding science fiction novels, films, television shows, comics, and video games had trained audiences to assume that the future of human-computer interaction (HCI) would be interacting with luminous volumetric images, which would float registered in the viewer's 3D space; seeing or interacting with these images would, in the way of distant-future magicks, require no special glasses or optics.

Although Dennis Gabor wouldn't coin the term “hologram” until 1947 (1949, 1971), in his 1928 novella *Crashing Suns*, Edmond Hamilton describes the “telestereo”—a communications device on the bridge of a starship upon which “*appeared...the image of a man...a lifesize and moving and stereoscopically perfect image...Through the medium of that projected image the man himself could see and hear me as well as I could see and hear him, and at once he spoke directly to me.*” Similarly, in 1934, E.E. “Doc” Smith's *Triplanetary* included a navigational “tank”—“*the immense, three-dimensional, minutely cubed model of the entire Solar System.*”¹

Robert Heinlein and other Golden Age science fiction writers quickly followed suit with their own descriptions of volumetric display systems. As science fiction moved from the page to the screen, film and television designers provided visual interpretations using half-silvered mirrors or optical composite photography. Over time, any luminous interactive volume of information began to be called a “hologram.”

¹ In a letter to Smith, *Astounding Science Fiction* editor John W. Campbell claimed that then-Captain Cal Laning, later rear admiral and chief of communications for NATO forces in Southern Europe, had acknowledged that Smith's ideas inspired the design of the US Navy's Combat Information Centers. According to Campbell, who may have embellished the story for greater effect: “The entire set-up was taken specifically, directly, and consciously from the *Directrix*. In your story, you reached the situation the Navy was in—more communication channels than integration techniques to handle it. You proposed such an integrating technique and proved how advantageous it could be. You, sir, were 100% right. As the Japanese Navy—not the hypothetical Boskonian fleet—learned at an appalling cost.” (Wysocki 2011)

Although holographers are vigilant against the misuse of the term “hologram” to describe visual phenomena that do not qualify as such (see, for example, *Slice of MIT*'s January 7, 2019 interview with Media Lab alum Daniel Smalley, “Debunking the Princess Leia Lie”), the popular but incorrect use of the term is only accelerating. Even companies such as Microsoft have joined in the dilution of the term with products such as their near-to-eye augmented reality “Hololens” product.

Clearly cultural expectations and physics are mismatched. To create a luminous, dynamic, interactive display environment seen in such films as *Iron Man* or *Prometheus* would require novel physics or a completely new way of thinking about how to display information that appears to fall within the visual field of a user or group of users. The ability of users, individually or in groups, to physically interact with a floating aerial lightfield without face-worn binocular optics is a particularly difficult challenge.

Objects in a science fiction future must appear to have a past from which they have progressed in order for audience members to understand their use and operation. The *fictional user interfaces* (FUI) created by Hollywood designers and instantiated by visual effects artists often extrapolate from current and well-used forms of information display. The moment R2-D2 begins to play the “hologram” of Princess Leia’s plea for rescue, he appears to operate like a standard film projector, including a frustum of light emitting from a lens while the resulting image magically coalesces in 3D space, correctly registered to the local surface with all of the proper parallax view angles provided to multiple users.

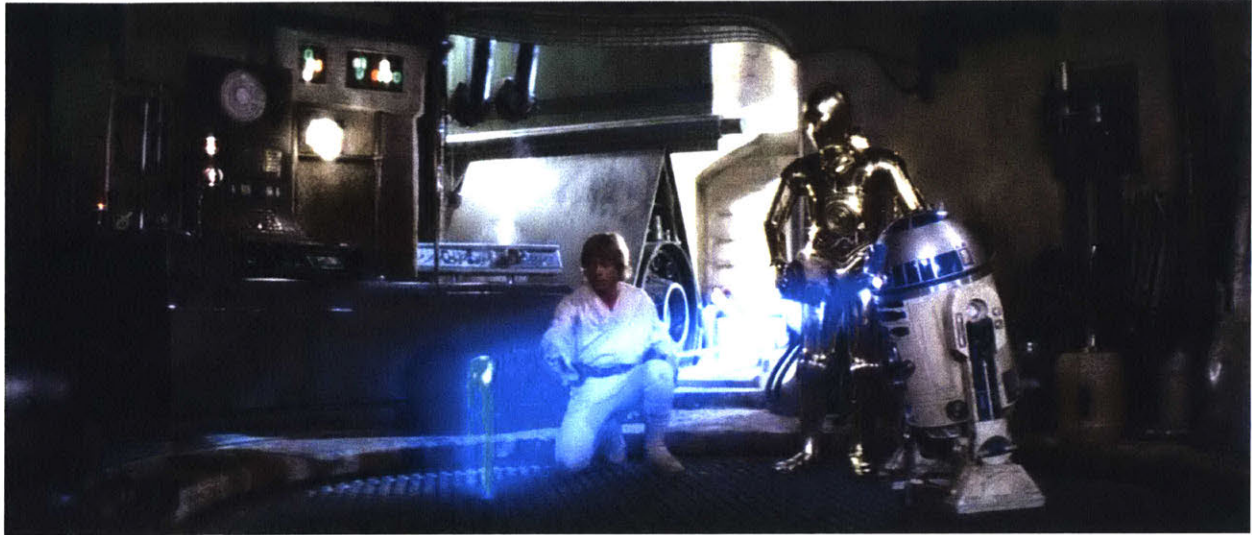

Figure 1: The Princess Leia Lie

Holograms simply do not operate in this fashion. While a real hologram can be viewed by multiple users, who will also be provided the correct parallax view, these tend to be either static images on a photographic medium, or dynamically generated but of small size. Companies such as Zebra Imaging (now owned by HoloTech Switzerland AG) have developed technology to record and work with very large holograms in a team environment, but these, again, are non-interactive and more akin to working at a traditional map table (Eisenberg 2010). Full-motion, true-color, high-framerate holography is within our reach, but still requires transmissive optics and has yet to be scaled for full-room interaction. Regardless of scale and resolution, true holographic systems do not allow one to point a beam of light at an arbitrary surface in any room and have the resultant hologram appear in perfect registration out of thin air.

Recently several virtual, augmented, and mixed reality (VR, AR, and MR) display solutions have gained traction in industry and consumer markets. While these near-to-eye display systems may differ in their underlying computational frameworks and some optical elements, they all share similar physical form factors imposed by the use of transmissive and reflective screens, lenses, or

transparent *holographic optical elements* (HOE) to relay imagery into the eye. They are all, to some extent, glasses-, visor-, or goggle-bound.

Realtime computational holography would seem to answer many of the shortcomings of glasses-bound mixed reality, such as *accommodation-vergence mismatch*, yet even holographic solutions require a transparent medium with an outcoupler to place the hologram within view of the eye.

New non-holographic systems that project a laser-based lightfield directly onto the retina show promise for levels of fidelity and luminance. Companies such as Magic Leap are using diffractive optical elements, gratings, and stacked silicon waveguides coupled to a biaxially scanning cantilevered optical fiber tip to create nano-structured lightfields. The optical element “chip,” not a lens, is still in the line of sight of the eye (Abovitz, Schowengerdt, and Watson 2015). While this approach creates what appear to be high-resolution and relatively opaque objects with the field of view, they are severely limited in field of view (FOV) and, more substantially, in the number of depth planes that can be addressed.

Researchers at the MIT Media Lab have created *volumetric aerial lightfield displays* that provide dynamic, interactive, horizontally correct parallax views and can be used without any head- or face-worn accoutrements, but these systems are also large and still in their infancy. The number of views is limited by the small number of projectors arranged in an arc and the angular field of view results in a FOV of less than 90 degrees. Material science limitations also constrain the fidelity of the projected lightfield, which relies on retroreflective relay optics to place the lightfield into 3D space (Novy and Bove 2015).

Beyond even the Princess Leia illusion, *Star Trek*'s Holodeck is considered to be the ultimate display system. Unmatched in its ability to create an immersive training or entertainment scenario, it uses a hybrid of “just in time” matter compilation and holographic projection to let

users move about the volume at any speed, from any angle, through a projected storyworld or training simulation that is correctly rendered as indistinguishable from reality. Universities such as NYU are currently working to make a functional version of the Holodeck (“Holodeck” 2016), and researchers around the globe use the term “holodeck” to describe a collection or ecosystem of display and haptic solutions, such as previously described, to approximate its functionalities.



Figure 2: A fictional user interface (FUI) from Iron Man 3 (Marvel Studios 2013).

But what if we could create a true quantum leap in display technology and develop a form of information display that isn't an extrapolation of a past or current interaction model? What if we could leapfrog into a much broader future?

In Philip K. Dick's *Do Androids Dream of Electric Sheep* (1968), characters interact with a fictional device known as the Penfield Mood Organ. This home appliance allows one to “dial” any mood one wishes to have. It is, essentially, an electroceutical neurostimulation device that

suggests a possible future solution to a visual information display. If, fictionally, some form of information-carrying energy can be passed into the brain and affect the emotional centers, could some similar process be investigated, instantiated in the real world, and utilized to create percepts in the visual cortex that would be interpreted by higher attentional areas as if the stimulus were coming from the eye, and eventually be perceived as imagery by the user?

This simple question led to the birth of a new field of inquiry, open to all, currently termed *Programmable Synthetic Hallucinations*.

Programmable Synthetic Hallucinations is a new, widely interpretable field rife with possibilities. It describes, broadly, the utilization of the bio-physiological mechanics of hallucination generated in the human brain to display virtual information or content directly in the consciousness of a human being. Programmable Synthetic Hallucinations needn't be limited exclusively to the visual field. Hallucinations are as varied as the individuals experiencing or describing them. There are tactile, proprioceptive, olfactory, and gustatory hallucinations. Any or all of these become possible effects an investigator might try to emulate for study, simulation, science, or entertainment. Higher structures such as memories, feelings, and beliefs can also be experienced hallucinatorily and could be investigated as well.

Pragmatically, can we provide you with the memory of a path to a place you've never been, with the same ingrained assurance and confidence of the path you take home every day? Can we provide the experiences of elation and terror as you save the world from invaders who hail from another dimension of spacetime; or elicit H. P. Lovecraft's existential dread nibbling at your brainstem as you approach the barn in Dunwich? Whether placing simple text-based content in the visual field or including the affordances of a full temporal lobe seizure, the brain is capable

of generating high-resolution content—we just need to figure out how it does that, and how we can emulate it.

“And in the bloodlit dark behind his eyes, silver phosphenes boiled in from the edge of space, hypnagogic images jerking past like a film compiled of random frames. Symbols, figures, faces, a blurred, fragmented mandala of visual information.”—William Gibson, Neuromancer

CHAPTER 2: BACKGROUND AND PRIOR ART

Neurostimulating Lies for Fun and Profit!

As mentioned above, the Penfield Mood Organ was originally created in the late '60s as a loose metaphor for the possible dangers of the over-prescription of mood-altering pharmaceuticals.

Through the mechanism of the Mood Organ, Philip K. Dick explores the very human need to feel and express primal emotion. In the storyworld, everyone has the option to be deliriously happy all the time, but several characters reject it as an unnatural state of being. Iran, the wife of protagonist Rick Deckard, uses the Penfield Mood Organ to experience “a self-accusatory depression” for six hours every Tuesday. She thinks “that's a reasonable amount of time to feel hopeless about everything.”

The desire to experience the emotional states of others, along with the recognition that negative emotions aren't necessarily bad, are part of the basic allure of the art of storytelling. By simulating another's story, we stimulate our own emotions. We live and feel more than the single life and time we are allotted. The empathy learned from these emotional explorations provides a richer humanity; for ourselves and for others. Solutions to conflicts we've never faced can be simulated, experienced, recalled, and enacted should we ever find ourselves in a situation similar to a protagonist from a well-loved story (Oatley 2016). We simulate and stimulate through many media, from oral stories told by the firelight, to symbolic marks on paper that became novels and comics, to the moving images of the cinema, television, video games, and now mixed reality displays.

It is precisely this desire to make these static and moving images better stimulate our emotions that led to many advances in the field. Let us take music, for example. Well before the addition of sync sound, music was used to accompany the flickering phantasmagoria on the movie screen.

But more than that, music has been an expressive medium of emotion since its creation, and acts directly upon the limbic system. The musical score of a film suggests, highlights, and amplifies the emotional score of the film, alerting the viewer to moments of quiet contemplation, sustained dread, or epic glory. Music is, essentially, an aural, sonic energy-based Penfield Mood Organ that works in tandem with the projected or displayed images to provide any emotion the director, editor, and composer want you to have.

Although some researchers, such as Manfred Clynes, believe that music has inherent affective characteristics, music does have its shortcomings as an emotional stimulator. The emotional quotient of music—as in what type of music is supposed to incite which emotion—is culturally bound and absorbed as one grows up. A soundtrack intended to evoke a sweeping vista may sound like dissonant noise to a visitor from another culture. Pizzicato plucking meant to induce dread in one culture's horror film may be interpreted as humorous by another.

However, cultural differences do not override the underlying unified nature of the human brain. All humans, controlling for a certain value of operational tolerances, experience similar emotions, regardless of the impulse that triggers them. Emotions arise as operating feedback from actions in the limbic system, an area of the brain thought to predate the higher functions of the newer cortices. Without ever explaining how it operates, as no science fiction author is ever required to do, Dick's Mood Organ connects the emotions desired with the limbic system at the press of a button or the turn of a dial.

But just how fanciful is the Penfield Mood Organ? What if we could directly stimulate the emotional responses of the limbic system and score them just like music as part of a mediated experience? Direct elicitation of strong emotion via limbic stimulation has been possible for many years. It was studied by Wilder Penfield (1958), for whom Dick named the Mood Organ,

and more deeply by Jose Delgado, who implanted stimulators with a radio receiver that could be triggered wirelessly. Called a “stimoceiver,” Delgado’s device could be wired directly into the brains of cats, bulls, primates, and humans. With it, he could induce fear, rage, lust, hilarity, garrulousness, and other reactions, some of them startling in their intensity (Horgan 2005).

While building a functional Penfield Mood Organ makes for a challenging mental exercise, the real thing is many years away—any current version would be messily invasive. If we begin to look at other forms of neurostimulation that can be used to cross the skull-brain barrier and are capable of carrying modulated information, then, what other regions of the brain and sensorium can we reach with readily available technologies? Well, what if instead of emotional cues, we tried projecting visual information directly into the perception of a human (or non-human) brain? Unlike current VR/AR/MR goggles or Google Glass-type systems, the novel display system described below is designed to place information directly in the visual field of the user without the use of reflecting or diffractive holographic optics, transmissive screens, or diffusing materials worn in front of the eye. While it seems counter-intuitive not to use the retina to place information in the visual field—it evolved over billions of years to do so exquisitely—there are reasons we may want to bypass it.

Practically speaking, keeping the face of the user unobstructed in scenarios such as combat or gaming sessions is more natural and comfortable, which could improve performance. Although a fighter pilot’s clear face shield may contribute to his or her safety, the amount and type of information that must be displayed on it, or on the glass of the cockpit, is ever-increasing and spatially limited. Current cockpit heads-up displays (HUDs) predominantly use transparent holographic optical elements with various dynamically controlled diffractive gratings to outcouple the light signal. These tend to be collimated displays (i.e., images at optical infinity),

which project virtual objects that appear to be very far away. Cockpit and helmet displays are not designed to focus on close-up information.

Socially, removing perceivable technology that obstructs the user's face would also limit the "Glasshole" effect, which alienates the non-display wearing member of a conversation or interaction. The inability to see the eye clearly and track the gaze of a display-wearing user makes it difficult to read nonverbal cues or even determine whether the glass-wearing member is paying attention. This alienating effect is compounded when the user is wearing goggle-based VR solutions that completely obfuscate the area of the face traditionally used to transmit social cues. While lightweight, vision-correcting glass spectacles have been worn for centuries, and may therefore be less off-putting than purpose-built goggles, there is a limit to the size and weight of display-enabling hardware that can be attached to normal glasses and comfortably worn for extended periods of time.

To create a display system with no optics of any kind in front of the eye, we turn to the mechanics of vision and hallucination. Although hallucinations are often seen as a debilitating side effect of certain forms of mental illness, they also demonstrate the brain's ability to create incredibly detailed, lifelike, motion-tracked, pervasive imagery at a level of resolution and fidelity of which video game and VR systems can only dream.

We can take the first steps toward this goal without invasive surgery or chemical stimulation, by using our knowledge of retinal stimulation and signaling from the eye to the visual cortex, which is well-understood. The mapping of the retina to the V1 area of the occipital region of the brain, considering foveal versus non-foveal photoreceptor density as well as color versus movement information, has been characterized on a physical level via fMRI by Engel et al. (1994), and as a signal processing challenge by Nirenberg and Pandarinath (2012).

Visual Cortices

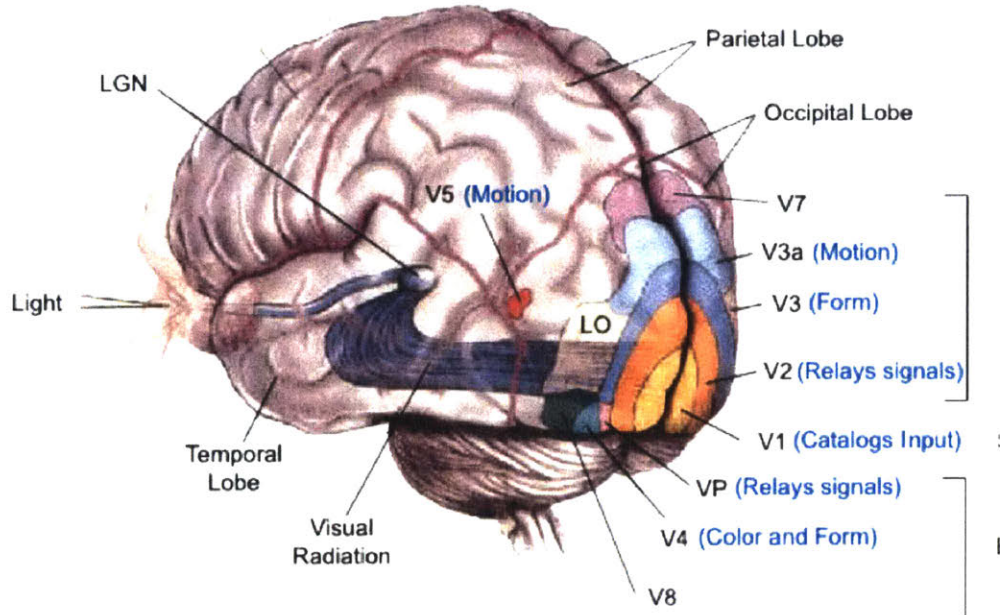

Figure 3: Visual processing areas of the occipital lobe.

The visual cortex and its functional areas occupy most of the occipital lobe in the extreme dorsal of the human skull. Stimulus from the eyes makes its way via the optic nerve and arrives in layer 4 of V1, which performs the most basic cataloging of input and then transfers the information through V2, which routes it to more specialized areas such as V3 and V3a for form and motion or V4 for color and form, eventually reaching higher and more specific levels of visual processing before being passed to the parietal of the medial-temporal lobe.

The visual cortex lies, on average, ~1.7cm from the outside of the skull, with the foveal region of V1 closest to the surface and occupying most of the occipital pole. V1 extends ventrally toward the interior of the brain with the remaining area of the retinotopic map dedicated to processing information from the peripheral vision. A convenient external anatomical landmark for locating

V1 is the inion, the highest point of the external occipital protuberance. This landmark is also used in the 10-20 system in electroencephalography (EEG) recording.

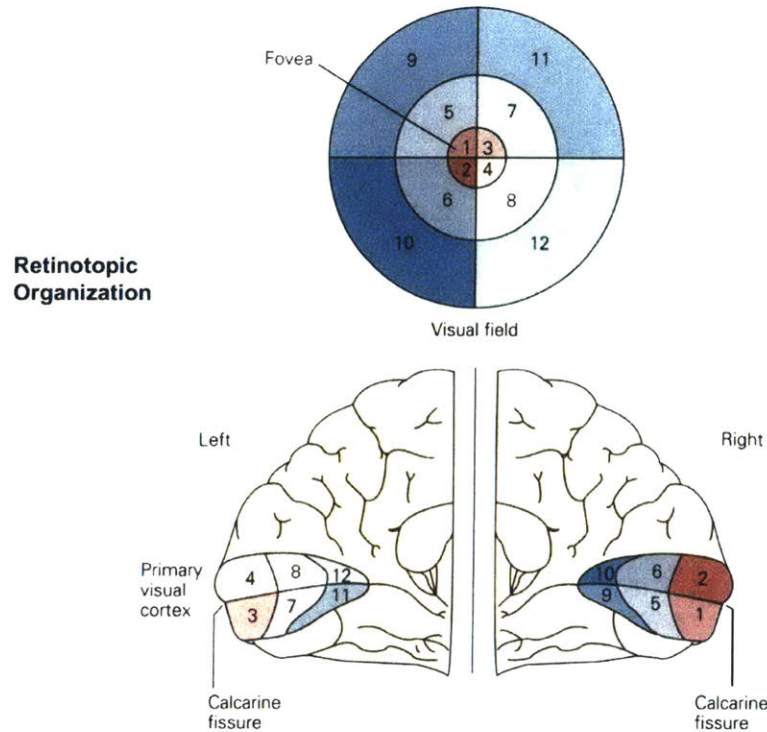

Figure 4: Retinotopic mapping of the visual field.

The retinotopic map translates to the visual field contralaterally and inverted. Any stimulus arriving from the retina arriving in V1 will be perceived on the opposite hemifield of where it arrives. Stimulus arriving below the calcarine fissure will be perceived in the vertically contralateral hemifield. Moreover, due to the density of neurons in the occipital pole devoted to foveal processing, even a small number of activated neurons will express as a large portion of the visual field while less processing is devoted to peripheral vision located deeper in the cortical area. This phenomenon is known as cortical magnification and must be considered when

attempting to stimulate any part of the visual system. Stimulating even a slightly-too-large portion of the foveal region could lead to activation of the entire visual field, which places an initial constraint on any novel stimulation system.

While we do not yet have the ability to activate individual neurons to recreate a neuro-electrical pattern indiscernible from the perception of reality, a solution involving the creation of luminous phenomena (phosphenes) within the visual field by stimulating neurons in the visual cortex may be a viable start.

By electrically stimulating the cells in the hypercolumns of V1, one can induce the perception of a pixel of light within the visual field of a user. Indeed, techniques for inducing phosphenes in the human visual system have been known for thousands of years. Retinal phosphenes, the colorful fireworks-like percepts one sees when one rubs one's eyes, were first reported in Western literature by Alcmaeon of Croton in the fifth century BCE (Grüsser and Hagner 1990). Charles LeRoy induced the first verifiably reported electrophosphene in 1755, while attempting to cure blindness with a Leyden jar (Marg 1991; Wagner, Valero-Cabre, and Pascual-Leone 2007).

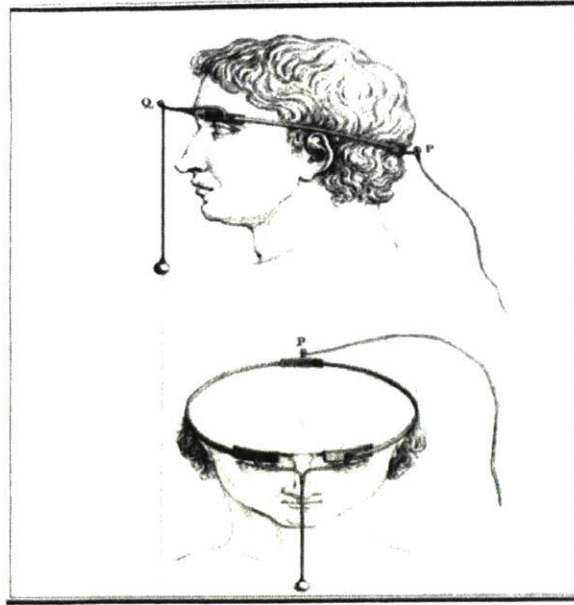

Figure 5: Retinal electrophosphene induction, 1755

More recently, neurologist Otfried Foerster created phosphenes by electrical stimulation of the brain as early as 1929 (Lewis and Rosenfeld 2016). Giles Brindley and David Lewin inserted a matrix of stimulating electrodes directly into the visual cortex using small pulses of electricity to create phosphenes. These phosphenes were repeatable and authorable, consisting of points, spots, and bars of colorless or colored light (Brindley and Lewin 1968). Brindley and Rushton later created a primitive neuroprosthesis that used phosphenes to depict Braille spots (1974). William H. Dobbie developed more advanced brain-computer interfaces utilizing stimulation of phosphenes; his system gave a user who had been optically blind for over 30 years, but whose visual cortex was intact, the ability to see edges and text (Dobbie, Mladejovsky, and Girvin 1974).

While these examples are all invasive, it must be noted that there are several ways to stimulate phosphenes noninvasively, including transcranial ultrasound, transcranial magnetic stimulation (TMS), time interference direct current stimulation (TI) (Grossman, Bono, and Boyden 2019),

and other forms of energetic radiation. A phosphene created by the use of a magnetic field was first reported late in the 19th century by Arsène d'Arsonval, the inventor of the moving coil electric meter (Marg 1991). In 1910, S. P. Thompson, head of the British Institution of Electrical Engineers and the Physical Society, coined the term “magnetophosphene” while working with a 0.14-Tesla coil (ibid.). NASA undertook a study related to the creation of phosphenes by energetic radiation—determined to be the result of high-energy particles traveling through the eyeball—after Buzz Aldrin and other astronauts reported seeing light flashes in space, beginning with the Apollo 11 flight to the Moon in 1969 (Cooray, Cooray, and Dwyer 2011).

A naturally occurring retinophosphene-related hallucination, often called the “Prisoner’s Cinema,” is one in which an observer, kept for prolonged periods of time in low light and social isolation, will begin to uncontrollably see human forms and other imagery evolving out of the naturally occurring phosphenes created by electrical noise of the photoreceptors in the eye. Truck drivers, pilots, and astronauts are also subject to this phenomena.



Figure 6: S. P. Thompson attempting to evoke a magnetophosphene in 1910.

Externally induced retinal phosphenes preexist as performance elements in the work of David Rosenboom, who applied small current pulses to the temple areas with varying waveforms, timing, and rhythms. This work was presented in a “biomusic and biovisual” installation-performance event, entitled “Ecology of the Skin,” at Automation House in New York City on 4 December 1970. Several stations were distributed around the space that enabled audience members to stimulate visual phosphenes by pressing electrodes to their temples, allowing each person could see their own, private, individualized light show (Rosenboom 1975).

Similarly, filmmaker, video artist, and musician Stephen Beck created what he calls “The Phosphotron” at the University of Illinois at Urbana-Champaign in 1968; he rebuilt the system in 1983 for the San Francisco International Video Festival, and finally patented it in 1987. Akin to Rosenboom’s work, Beck created “Group Phosphotron Seances” with a signal generator that allowed up to 12 participants to receive exactly the same signal amplitude and waveform in an attempt to create synchronized retinophosphenes across a group while listening to live music. (See Figure 7: Schematic of analog Phosphotron from US Patent filing). It is of interest that his findings include the steep fall-off of phosphene activity above 40Hz, as well as the predilection of certain phosphene shapes to be generated by certain frequency ranges. These findings were also substantiated in a joint research paper by the German Institute for Electronic Research and the Department of History of Art, Yale University (Knoll et al. 2009).

Beck also noted a “long-term goal of making a phosphenic form of television.” He asks, “Can we develop enough precision in the stimulation waveform to produce a specific, photographic image in the viewer? If so we might be able to eliminate the screen from television entirely” (Beck 1984).

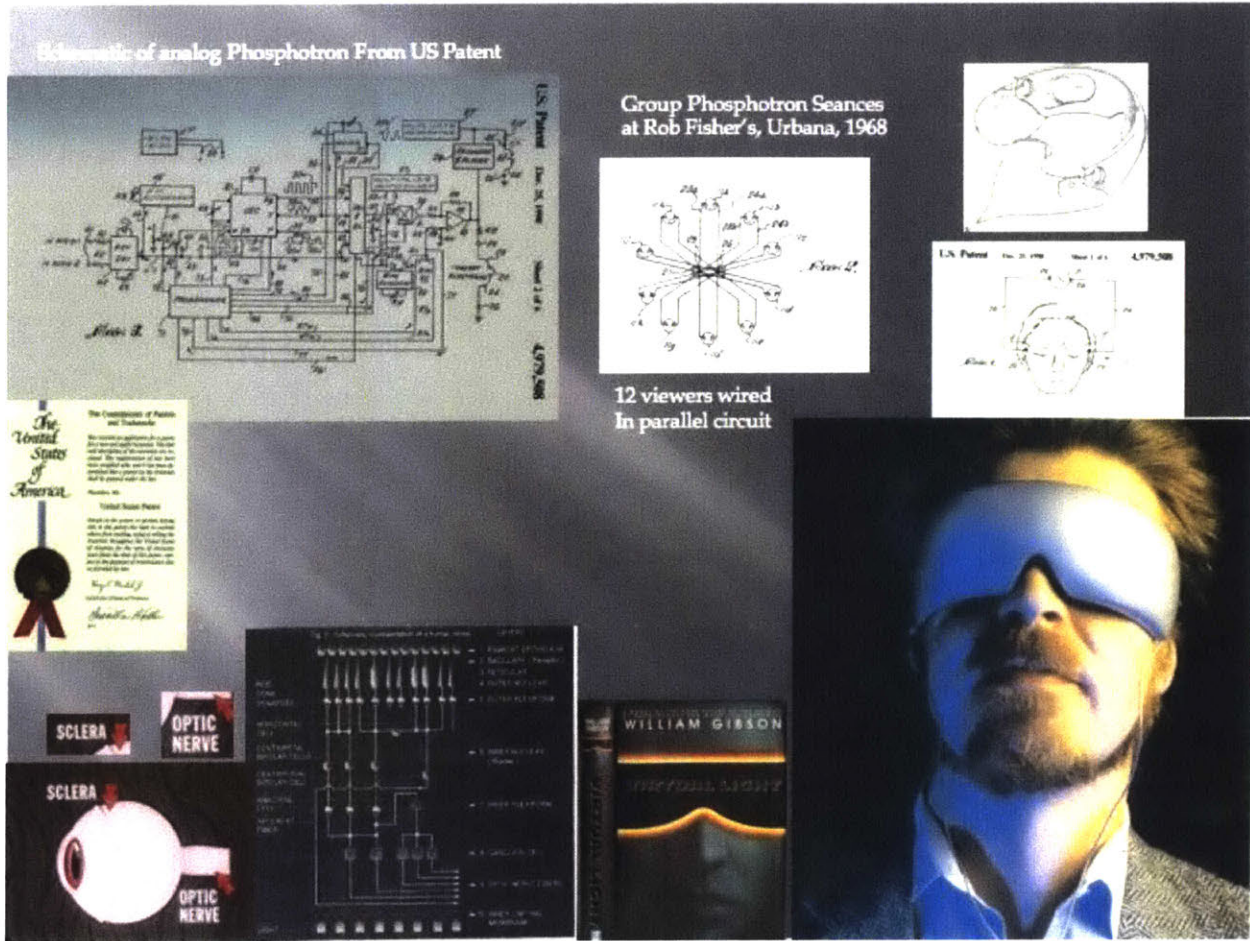

Figure 7: Schematic of analog Phosphotron from US Patent filing (Beck 1987), with illustrations of its use and inspirations. Image from Stephen Beck's website (<http://www.stevebeck.tv/phosphotron.htm>).

Magnetophosphenes, visual perceptions described as luminous shapes (ovals, bubbles, lines, patches), can be created by time varying magnetic fields $\mathbf{B}(\mathbf{x}, t)$, described by the vector potential $\mathbf{A}(\mathbf{x}, t)$ from $\mathbf{B} = \nabla \times \mathbf{A}$, that induce sufficiently strong electric fields $\mathbf{E}_{\text{ind}}(\mathbf{x}, t) = -\partial_t \mathbf{A}(\mathbf{x}, t)$ to cause a local potential (determined via $\mathbf{E}_{\text{ind}}(\mathbf{x}, t) = -\nabla U_{\text{ind}}(\mathbf{x}, t)$) on the membrane exceeding $U_{\text{ind}} > U_{\text{thr}}$

(Peer and Kendl 2010)

These change the membrane potential and trigger an action potential directly in neurons of the visual cortex. Phosphenes are perceived when the local induced field amplitude exceeds values in the range of 20–50 V/m, with varying thresholds in different subjects, and appear stronger and brighter with increasing stimulus strength (Peer and Kendl 2010). Personal experimental results suggest that these mostly appear as a scintillating silver, white, or a desaturated purple becoming a yellow similar in quality to an afterimage. The duration of perception matches the length of the pulsed stimulus. Magnetophosphenes appear and translate contralaterally to the location and direction of the stimulating coil.

To date, no information or example has been found indicating the use of cortical phosphenes, induced magnetically or otherwise, in performance or public display, although they have been used in clinical settings.

In 2014, researchers at The Beth Israel Deaconess Berenson-Allen Center for Noninvasive Brain Stimulation pioneered an original “brain-to-brain” communication system across the Internet using EEG and a TMS induced phosphene (Grau et al. 2014). An “Emitter” in Thiruvananthapuram (Kerala state, India) encoded a message into 0s or 1s using “motor imagery,” literally thinking about using their hands or feet. An EEG sensing the motor cortex was able to read whether there was heightened activity in the hands or feet area of the cortex. If there was activity in the hands area, a positive bit, or a 1, was sent across the Internet to a “Receiver” in Strasbourg, France. If the feet area of the cortex was active, a negative, or 0, bit would be transmitted. The Receiver would undergo a single biphasic pulse from a commercial transcranial magnetic stimulation device if a 1 was transmitted and no pulse for a 0, ideally resulting in a cortical phosphene reported by the Receiver for every positive bit transmitted. The Receiver would then decode the message from the string of bits they had just received. This

direct brain-to-brain (B2B) communication is thought to be the first bypass of “traditional language-based or other motor/PNS mediated means in interpersonal communication” (ibid.)

2016 saw the advent of a video game that used TMS and an evoked cortical phosphene to control the motion of a character in a maze (Losey et al. 2016). Researchers from the Center for Sensorimotor Neural Engineering at the University of Washington created a maze-based video game in which a character can only move to the right or down. A subject who had been screened and thresholded for phosphene elicitation was fitted to a TMS machine and instructed to control the movement of the character through the maze. The subject could not see the maze, but had been told that if there was a wall directly in front of them, they would receive a suprathreshold TMS pulse and perceive a phosphene, in which case they should move down. If they received a subthreshold pulse, and hence no phosphene was evoked, the way to the right was open and they should continue on. (See Figure 8: Typical maze to be solved unseen based only on phosphene perception) A researcher controlling the TMS device would then provide the correct pulse, allowing the subject to move the character based on whether they’d seen the phosphene. Subjects were able to navigate over 70 percent of the mazes encounters using this method, compared to 0 percent of control mazes in which only subthreshold sham pulses were transmitted.

Germane to the dissertation topic, researcher Rajesh Rao asked, “Can the brain make use of artificial information that it’s never seen before, that is delivered directly to the brain, to navigate a virtual world or do useful tasks without other sensory input?” According to this study, “the answer is yes” (Alba 2016).

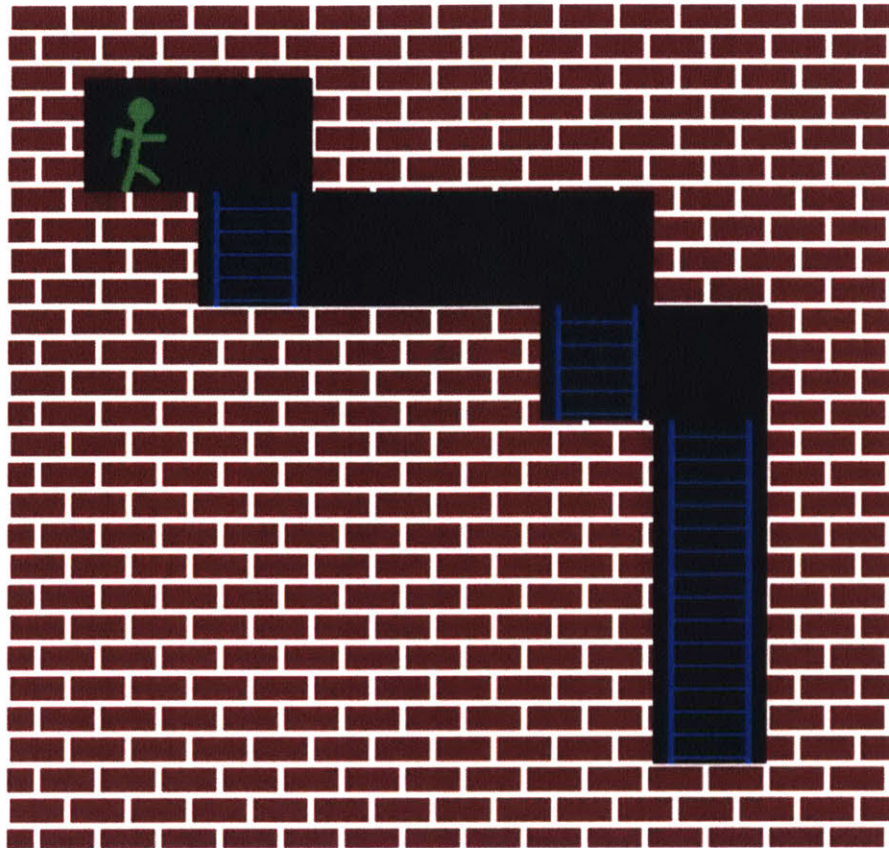

Figure 8: Typical maze to be solved unseen based only on phosphene perception (Losey et al. 2016).

Recently, researchers from the University of Washington and Carnegie Mellon collaborated on BrainNet, a networked version of Tetris that also involved the transfer of a decision by one participant over a network with the binary result of the presence or absence of a phosphene in another participant’s visual field. In this case, the “Sender” would send the request to rotate a Tetris piece to a “Receiver” who could not see the screen. If a phosphene was evoked in the Receiver’s visual field, the Receiver would rotate the piece, which would then update on the Sender’s screen, allowing them to correctly place the Tetris piece and continue on with the next piece. Again, this schema sends only a “Yes/No—Phosphene/No Phosphene” bit across the network and the subject reacts to the binary presence or absence (Jiang et al. 2018).

There is currently no locative or spatially targeted information involved in either of these studies.

“When you want to know how things really work, study them when they're coming apart.”

–William Gibson, Zero History

CHAPTER 3: IMPLEMENTATION

TMS Basics

At the inception of the thesis, several forms of transcranial-capable energies were investigated. Tantalizingly, transcranial ultrasound has also been reported to create cortical phosphenes and can be focused to approximately one square millimeter, similar to the area of the hypercolumn cells the focal point would be stimulating. This approach would allow for a finer dot pitch and a higher resolution display. However, while ultrasound is considered safe and is FDA-approved for neuroimaging, there was recent work which indicates that prolonged exposure of brain tissue to the mechanical shaking and thermal effects of ultrasound might be harmful (Shankar and Pagel 2011). While the energy used for neuromodulation is almost an order of magnitude less than that of imaging, we felt that obtaining approval from MIT's Committee on the Use of Humans as Experimental Subjects (COUHES) for a perhaps first-ever, off-label use of transcranial ultrasound as a display mechanism would be difficult. TMS had been used in several phosphene studies—mainly for diagnostic, excitability, and mapping purposes—so magnetic stimulation seemed to be a safer option with an easier path toward COUHES approval.

While TMS may be a gentler method than ultrasound, there is a focality vs. penetration penalty (Deng, Lisanby, and Peterchev 2013). As of now, commercial transcranial magnetic stimulators can only be “focused” to an area approaching one square centimeter. This is enormous compared to the size of the hypercolumn cells. Magnetic “beamforming” (truly a misnomer, as magnetic fields are non-radiative and cannot be shaped using constructive and destructive interference) used as a spatial filtering technique is currently an active area of research in

magnetoencephalography (MEG). MEG, however, is the inverse problem of our TMS approach, that of a “read” versus a “write.”

TMS functions by inducing a current in cortical tissues as a result of a quickly changing magnetic field created by a high-voltage pulse through an electromagnetic coil or set of coils. To cause charge transfer across the membrane and cause depolarization, the pulse must be of adequate strength but also of short duration. The strength-duration curve must be considered as one of the physical principles driving many of the other engineering variables. Depolarization of an excitable membrane requires a flow of electrical charge across the membrane. The duration of the pulse must be shorter than the time constant of the neuron (typically ~1 ms), but the pulse must also be also a specific shape, so that the charge crosses the membrane rather than running along it. (“Strength-Duration Curve” n.d.)

Taken together, the most effective TMS pulse should be a biphasic discharge in which the dI/dt (rate of change of coil current) and hence dB/dt (rate of change of magnetic field) rise times are sufficiently steep and the first half-cycle is approximately 120 ms. The initial current direction will affect only those neurons at ideal orientations to its direction. Orientation of the tissue membranes matters in that:

[If] the electric field is uniform and parallel to the nerve axon, it will cause current to flow both inside and outside but not across its membrane. However, by continuity, if the current within the axon changes along its length, a current equivalent to the change must pass through the membrane and can cause stimulation. The mathematical description of this change of electric field along the axon is the spatial derivative of the electric field along it. In the case of a bent nerve, even a spatially uniform electric field can cause stimulation. This stimulation occurs because at the place where the axon bends across the

field, although the magnitude of the spatial derivative of the electric field does not change, its spatial derivative along the nerve will
—(George et al. 2007; citing Barker et al. 1990).

The second half of the pulse, as the current reverses direction, improves the probability of affecting neurons at different orientations than those affected by the first positive cycle. Combined, the two current directions increase the likelihood of activation and raise the total possible number of neurons affected. The entire biphasic pulse should last from 240–300ms, with the remainder of the time constant allowing the neuron to re-polarize (George et al. 2007; citing Roth, Cohen, and Hallett 1991).

If one were unaware of the intricacies of the strength-duration curve and the importance of pulse shape and current direction on membrane potential, one might be tempted to simply find the largest capacitor one could and construct a coil to deliver the largest magnetic field possible. The chances of this successfully stimulating cortical tissue would be slight. Even while looking to increase the overall voltage and maximize current, one soon realizes that an ideal coil size, voltage, and induction quickly converges on the solutions many of the commercial devices already offer; only a small amount of flexibility is available within the system. Multichannel output was luckily one of the few options that commercial devices had yet to offer.

Concerning safety, the average power set free in the brain of a 1.4T commercial Magstim is less than 53uW, with a peak total current of approximately 0.25 amps induced (Marg 1991).

Manufacturers' estimates of the maximal charge density of currently available TMS devices are on the order of 2–3 $\mu\text{C}/\text{cm}^2$. This represents less than 0.001% of the heat generated in the brain from normal basal metabolism (ibid). Researchers have subjected themselves and patients to thousands of stimuli over many years without any significant untoward reaction (ibid.). By 1990,

Rosalind Kandler had done more than 800 transcranial magnetic stimulation studies on controls and on patients with neurological conditions, including 76 on stroke patients, without ever observing a seizure (Marg 1991; citing Kandler 1990). Tassinari et al. (2003) studied 58 patients with partial or general epilepsy without observing any seizures caused by low-frequency magnetic stimulation. Barker and colleagues have calculated the induced electrical, magnetic, and thermal energy of the stimulus and found them all much less than those associated with induced currents from magnetic resonance imaging (MRI) (as summarized in Marg 1991).

Other than the risk of seizure, electroencephalography (EEG) and magnetoencephalography (MEG) studies by Leonardo Cohen et al. have found no changes after magnetic stimulation. TMS does not seem to disrupt subsequent function (Marg 1991; citing L. G. Cohen and Hallett 1988). Currently approved by the FDA as therapy for severe depressive disorder, repetitive TMS is also being studied as a potential treatment for stroke rehabilitation, chronic pain, epilepsy, obsessive-compulsive disorder, post-traumatic stress disorder (PTSD), tinnitus, and movement disorders such as Parkinson's disease (Wassermann and Zimmermann 2012).

Due to the relative infancy of the field, there may be unknown effects from TMS (Bikson, Datta, and Elwassif 2009). Nick Davis worries there may be “unplanned effects from build-up of stimulating effects in non-target areas, or from build-up of effects across multiple sessions,” and notes the possibility that “inducing long-lasting changes in cortical excitability can be dangerous to the participant if not properly controlled” (Davis and van Koningsbruggen 2013). However, many of the sources cited for this concern seem to be more related to transcranial direct current stimulation than rTMS, and other studies indicate that TMS “does not have an adverse effect on cognitive function, despite its ability to disrupt brain processing, however transiently” (Evans 2007). Giorgio Bonmassar et al. also counter that in magnetic stimulation, as neither sinks nor sources are present when a current is induced by the time-varying magnetic field, magnetic

stimulation does not lead to charge buildup as can occur with electrical stimulation (Bonmassar, Gale, and Vanduffel 2014).

The Basics of TMS hardware.

At its most basic, a transcranial magnetic stimulator is a high-voltage pulse discharge electromagnet requiring the following elements:

- 1) A high voltage power supply capable of transforming 110–240V mains into many kilovolts at a high enough current to charge and recharge an energy storage capacitor quickly enough to allow refresh rates of at least 1Hz or greater. Care must be taken to isolate this charging circuit from the discharge pulse, as the negative half of a biphasic discharge can be almost the negative of the peak voltage.
- 2) An energy storage capacitor capable of holding several hundred joules of energy at a low enough capacity that the charge can be removed in a sub-millisecond pulse. If the capacitance is too large, the pulse duration will simply be too long for the time constant of the neuron (typically < 1 ms). Common electrolytic capacitors are not appropriate; specialized high-speed photography, medical defibrillator, or pulsed-laser capacitors are ideal. If a single large capacitor cannot be sourced, several smaller capacitors can be banked together in a combination of series and parallel to achieve the capacitance and voltage rating of a single larger component. Lessons from Tesla coils and mass ejectors are particularly useful should the need to assemble a capacitor in this way arise.
- 3) A pulse discharge network is usually a series of high-voltage, high-current switches and any protective diodes needed to allow the current to flow from the energy storage capacitor through the main discharge coil. These switches must be able to survive massive current loads, sometimes in excess of 10kA, for small amounts of time, and

should ideally be able to switch with sub-millisecond to nanosecond speeds. Many commercial systems use silicon-controlled rectifiers, but anything from thyristors, to trigatrons, to complex H bridge configurations of insulated-gate bipolar transistors (IGBTs) have been explored. The switches and their companion protection circuits must be able to withstand the rapid dV/dt of charging as well as the massive dI/dt of discharge—and they must be able to do it reliably for the maximum duty cycle the charging circuit can provide, and over the lifetime of the device.

- 4) A pulse trigger control network, ideally opto-isolated from the high-current discharge, which must reliably be able to activate the switching network from the capacitor, as well as monitor the state of the charge and discharge networks to ensure that the pulse is fired only when the operator or trigger control software request that it do so. For safety's sake, the pulse trigger control must also be able to empty the capacitor safely and quickly should the pulse not be able to be discharge through the main coil for any reason.
- 5) A user interface of some kind is necessary to initiate power up and charge cycles and discharges, whether singly or in preprogrammed pulse trains. The UI can be a series of hard-wired knobs, button, gauges, and switches; a microcontroller network the user interacts with via LED touchscreen display; or any combination of both.
- 6) The business end of any TMS system is of course the discharge coil itself. TMS coil design is a complete field unto itself and an area of active research. A simple air-core, multi-turn coil of copper wire is the most basic industry standard and grows in complexity from there. Entire PhD dissertations could be written about novel coil designs and engineering (see, for example, Koponen 2013). Needless to say, all coil materials must be chosen to withstand the massive currents released through them during discharge; be of adequate area and inductance to allow a quickly changing magnetic field

to penetrate the brain; and if pulsed at a high refresh rate, be able to shed the heat caused by even micro-ohms of resistance.

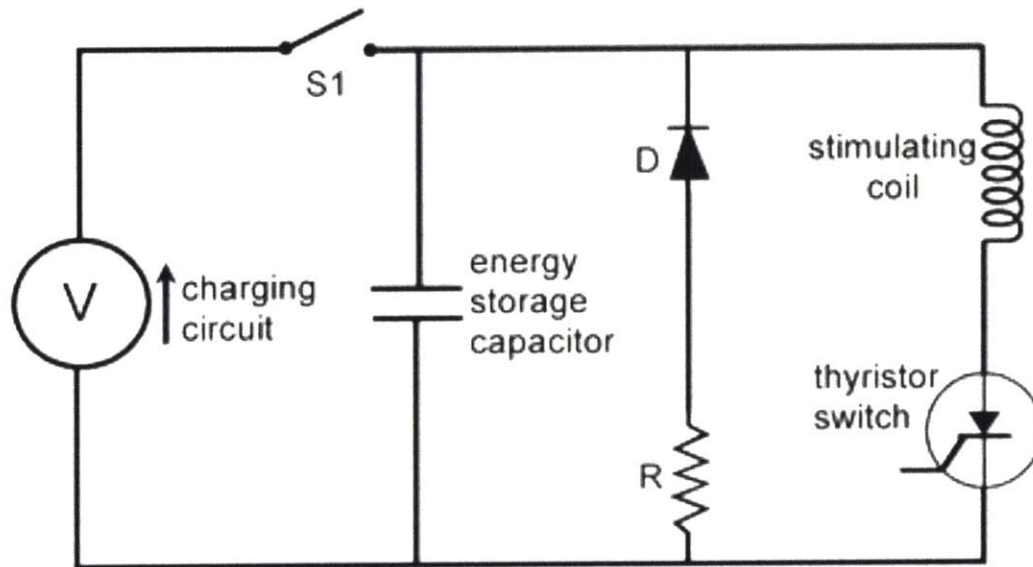

Figure 9: Basic TMS block diagram

Hardware Design

This section describes the construction of a multi-output channel, wearable transcranial magnetic stimulator developed based on plans available via the Internet, reverse engineering of commercial devices, patent searches, and the asking of many (many, many) questions. A prototype was assembled, with an eye to cost, from parts found in the author's group area, the Media Lab's loading dock and reuse area, eBay, Amazon, Digi-key, and Mouser.

The pulse energy of our device is estimated to be approximately 30 percent greater than that of typical commercial TMS systems from companies like Magstim, though at a much lower duty

cycle due to limitations in the charging circuit. The maximum dI/dt and dB/dt are comparable to that of several commercial systems.

Perusal of the dissertation proposal would indicate an original reliance on access to a functional, fully operational commercial transcranial magnetic stimulator. A Magstim Rapid 2 was made available for initial testing, discovery, and exploration of phosphene thresholds in a highly constrained test population (i.e., this investigator).

We approached Magstim's developer program and discussed the thesis proposal with a sales and support engineer. Magstim seemed intrigued and details such as wiring protocols and diagrams began to flow between the support engineer and the investigator. This continued for several weeks until an abrupt silence fell across the conversation. After several weeks and plaintive emails, a new sales and support engineer informed us that our previous contact was no longer with the company and all projects they had been involved in were considered dead on arrival. The company put us in contact with their American distributor, who had a developer program and indicated an interest in our topic and seemed supportive. After several weeks of back and forth they made it clear that for the low, low price of \$14,000 our group would be allowed to come aboard their developer program. Additional funds would then be required to aid in the development, design, and fabrication of our novel coil array.

Given budgetary constraints, it was determined that this course of action was untenable. While this amount could be amortized over several years of the project, making the per-year cost somewhat reasonable, the uncertainty of whether the proposal was even physically possible was a concern. Success was in no way assured. Alternatives were quickly investigated.

The investigative team still had a functional Magstim Rapid 2 and thought, perhaps, we could reverse-engineer the pinouts on the discharge system to allow a non-licensed, non-FDA-

approved coil device to be attached and used for research purposes. A cursory search of the Internet found several tear-downs of previous generations of Magstim devices by high-voltage hobbyists, and eventually of the pinout of the Rapid 2's 70mm double butterfly coil. Most importantly, the tear-downs revealed which pins were involved in the safety interlock system, which seemed to exist expressly to deter investigators such as ourselves from doing exactly what we were attempting to do.

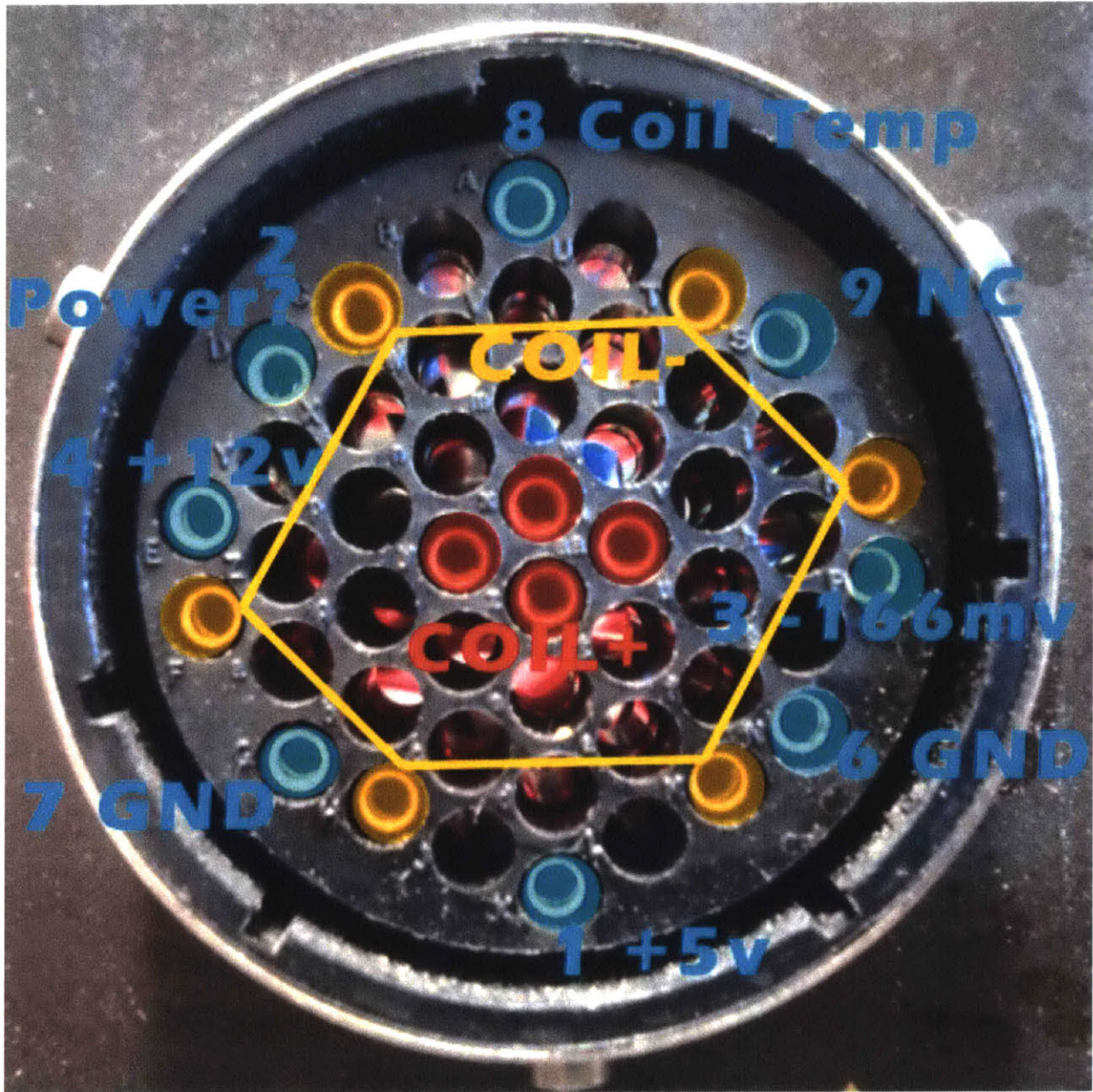

Figure 10: Pinout of commercial Magstim Rapid 2 connector.

We quickly decided this was also a less-than-ideal solution. Not only would it be dangerous to everyone involved—the investigator, the subjects, clinical research staff, etc.—but it would be highly unlikely that COUHES would approve a study involving a commercial medical device that had had its safety interlocks tampered with in any way. Additionally, not only was there a safety concern, but bypassing the device’s anti-tampering measures might expose the

investigator to Digital Millennium Copyright Act liability, which expressly forbid our course of action if the original patent holder's intellectual property, existing as compiled code on the device, was being circumvented and exploited in an unlicensed manner.

This approach was also abandoned.

A decision was made eventually made for us. The Magstim suddenly developed a disconcerting fault of self-firing before becoming fully charged.

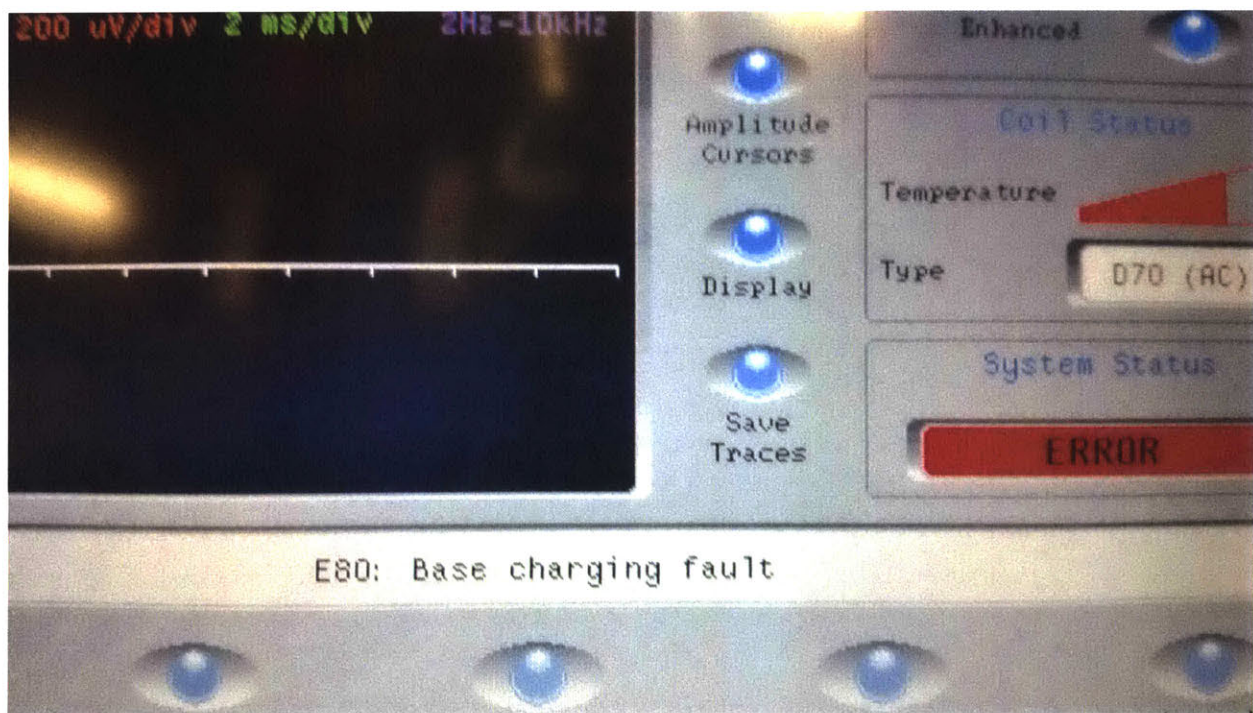
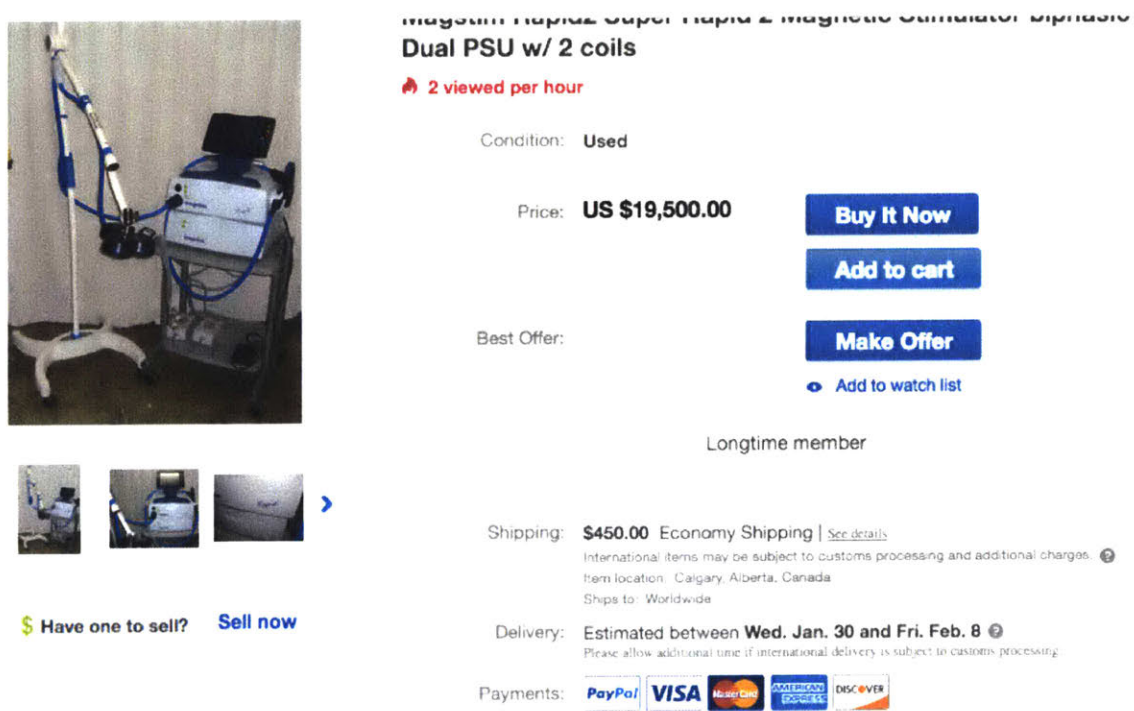

Figure 11: Error message on faulty Magstim Rapid 2.

The original distributor from whom the Magstim had been purchased was contacted and, after a brief technical support visit, determined that the main discharge silicon controlled rectifier (SCR) was faulty. While they graciously replaced the SCR even though the unit was well out of warranty, they determined there was also a fault in one of the charging blocks and urged us to retire the system as potentially no longer safe. This was, of course, followed by the offer of a

substantial trade-in value on the old system if we were inclined to purchase a new, top-of-the-line Magstim system and support contract.

The offer of a discounted new system was declined, as TMS was determined to be of less research interest to the current members of the Media Lab’s Synthetic Neurobiology group, who had loaned us the original Magstim Rapid 2. We then consulted eBay to see if a used Magstim could be obtained at a reasonable price.



Magstim Rapid 2 Super Rapid 2 magnetic stimulator Biphasic Dual PSU w/ 2 coils

🔥 2 viewed per hour

Condition: **Used**

Price: **US \$19,500.00**

Best Offer:

Buttons: **Buy It Now**, **Add to cart**, **Make Offer**, [Add to watch list](#)

Longtime member

Shipping: **\$450.00** Economy Shipping | [See details](#)
International items may be subject to customs processing and additional charges. 🌐
Item location: Calgary, Alberta, Canada
Ships to: Worldwide

Delivery: **Estimated between Wed. Jan. 30 and Fri. Feb. 8** 📅
Please allow additional time if international delivery is subject to customs processing.

Payments: [PayPal](#) [VISA](#) [Master Card](#) [AMERICAN EXPRESS](#) [DISCOVER](#)

[Have one to sell?](#) [Sell now](#)

Figure 12: eBay listing for an untested, yet allegedly operational, Magstim Rapid 2.

Pre-owned replacement units ran close to \$20,000, often untested, and always without a support contract. This approach was also clearly a non-starter.

This left one simple but daunting option. We would have to build a complete, multichannel transcranial magnetic stimulator, from the ground up, using the remains of the commercial device and any parts we could source within our budget constraints.

Our initial hardware designs were intended to be built into the headrest of a chair or the seat of a car, but time constraints led directly to the development of a lighter-weight wearable helmet. The wearable unit could then be later directly transposed into a flight or astronaut's helmet, a bicycle helmet, or construction hard hat form factor. Eventually, a slim headset held on by the ears—similar to a pair of oversized sunglasses worn backward—would become possible.

Prototype Specifications

These specifications apply to what was eventually dubbed the “Ono-Sendai Cyberspace 1,” in reference to the hardware used by the hero of William Gibson's seminal 1984 cyberpunk novel, *Neuromancer*. Early iterations were monolithic and fit completely within the remains of the commercial Magstim case from which it came. Initial coil designs were based on a custom manufactured Litz wire engineered to eliminate skin-effect and allow a higher current density to be used during the discharge pulse, thereby creating a stronger magnetic field without altering the pulse duration. The eventual design shifted the high-voltage power supply charging network to its own external case, for additional cooling and ease of maintenance. The charging current is limited by a tuned resistance network on the secondary side of the transformer, including a passive resistor capable of dispersing 1kW of power and a series of inrush current limiters using negative temperature coefficient (NTC) thermistors for good measure. The resistor network both limits the current from the transformer and provides isolation during the discharge to maintain a low damping factor.

System Specifications

- **Maximum energy storage capacitor voltage:** 3000v.
- **Coil resistance:** 0–0.04 ohms.
- **Coil termination:** 1/4–20 solder lugs.

- **Power controls:** AC main toggle and opto-isolated microprocessor-controlled relay.
- **Power indicators:** Line Power (Red 110v LED), High Voltage Power (Green 110v LED), System Charged (Yellow LED on control console).
- **Voltage adjust:** 0 to 2000v.
- **Pulse modes:** Single.
- **Pulse repetition rate:** ~1 pps.
- **Pulse types:** Biphasic/Damped Polyphasic.
- **Pulse indicators:** Luminance from spark gap as well as indicator LED on console.
- **Line voltage:** 110 VAC, fused 15 A.
- **Input power:** 1000W continuous.
- **Form factor:** Remains of commercial Magstim Rapid 2.
- **Maximum energy:** 380J.
- **Pulse types:** Biphasic/Damped Polyphasic
- **Coil inductance:** Air-core, 8 μ H total (2 x 4 μ H).
- **Coil Material:** 10kA rated 250C Litz wire or multi strand #14 AWG
- **Biphasic period:** 240 μ s (8 μ H coil).
- **Peak current:** 8000A (8 μ H coil) (originally 10kA with Litz wire and 6 μ H coil).
- **Maximum pulse repetition rate versus energy (biphasic):** 1pps at >90%.

Although the manufacturer claimed that the Litz wire was rated for 3kV and 10kA pulses (Talebinejad, Musallam, and Marble 2011), we found this not to be the case. While the wire was ideal in dimension for an optimal number of windings vs. diameter, the central coil was subject to at least three failure events after extended use and when the system was charged to near maximum. In our H-bridge configuration, the central coil's duty cycle is four times the duty

cycle of any of the four coils in the outer bridge. This likely explains why only the central coil ever suffered a failure event.

Electronics

The Ono-Sendai operates on as simplified a circuit design as possible. A high-voltage power supply consisting of a microwave oven transformer (MOT) capable of stepping up 110v mains to 2000v operating at 1000W is switched via an opto-isolated microprocessor-controlled relay into a 190 μ F energy storage capacitor designed for very rapid discharge. A voltage monitoring network allows for monitoring the charge level on the capacitor in real time. A switched, multichannel pulse-discharge network allows selective activation of any individual pairs of output coils and the activation of their combined flux focality. A low-voltage 12v/5v combined power supply provides current to all relays, switches, indicator lights, and fans. An opto-isolated micro-controller connected via shielded, twisted-pair ethernet cable provides logic, sensing, and switching.

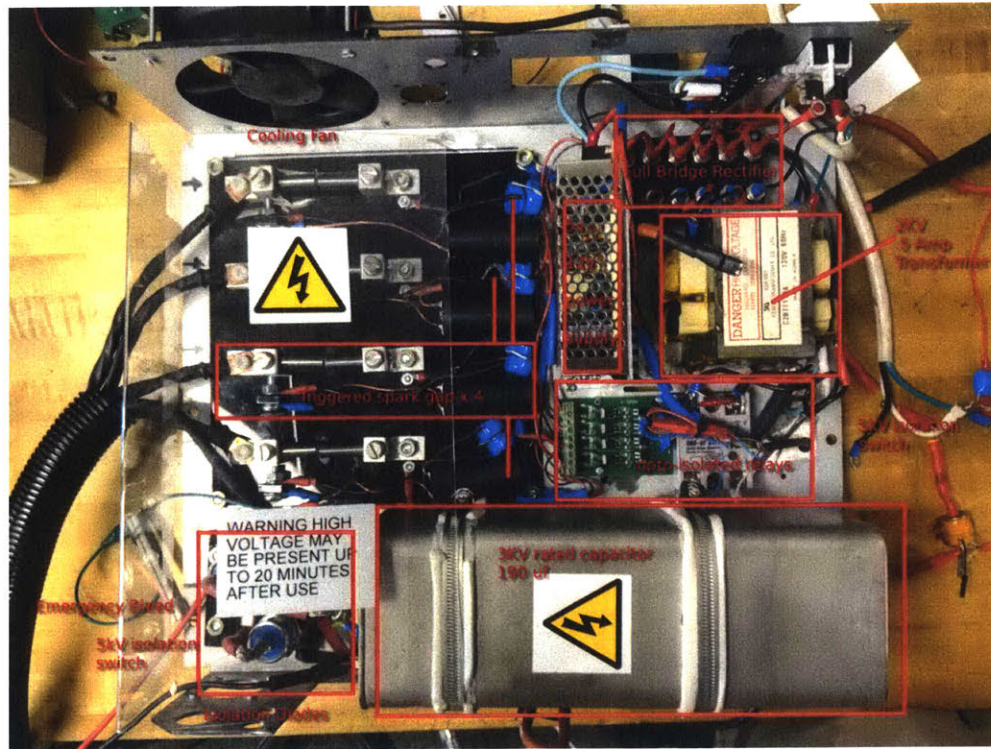

Figure 13: Interior of Ono-Sendai Cyberspace 1.

Pulsed magnetic discharge circuits share many similarities with pulsed laser power supplies, medical defibrillators, and reluctance launchers, also known as “mass drivers.” Indeed, the engineering principles of each of these has played a small part in the understanding and construction of this device. The high voltage power transformer from a 1000W microwave oven is switched on the primary side via opto-isolated microcontroller and was originally current-limited solely through pulse width modulation, ensuring that maximum current could be delivered to the capacitor to minimize charge time and attempt to maximize refresh rate and duty cycle. The 2kV supply was rectified through a full bridge diode configuration, again to maximize refresh rate, and then passed through a 5kV rated, single pole double throw (SPDT) solid-state switch operated by an opto-isolated 12v signal from the microcontroller. Two very large diodes

provide a one-way path into the capacitor and isolate the charging circuit from the capacitor during discharge.

As an added safety feature, the 5kV SPDT switch physically isolates the transformer and bridge rectifier from the capacitor during discharge. The high voltage supply path is only fully engaged during the charge cycle and disconnects and depowers the transformer while waiting for the capacitor to discharge. The capacitor's internal bleed resistor will eventually drain the lethal charge the storage system contains, but at 2000v this can take over an hour. An additional "bleeder" resistor network was constructed and configured as a "deadman" switch, allowing the full 2000v to drain from the capacitor in under five minutes, with very little heat created, should the device lose power or be manually turned off for any reason. A digital multimeter, running on its own battery to isolate it from any portion of the high-voltage path, is attached and on at all times to give an accurate, real-time account of the amount of charge left on the capacitor whether the main device is on or not.

Early iterations with only the pulse-width modulated, controlled high-voltage power supply and its full bridge rectification often saw saturation of the transformer's core if run on at a high duty cycle. The transformer would become audibly unhappy, vibrating harshly and growing concerningly warm. Although at 2000v and 1000W the transformer can only source 0.5A, the bridge rectifier diodes were all rated for 20A to allow for possible over-voltage or over-current situations, and in anticipation of the addition of parallel current sources to further increase refresh rate.

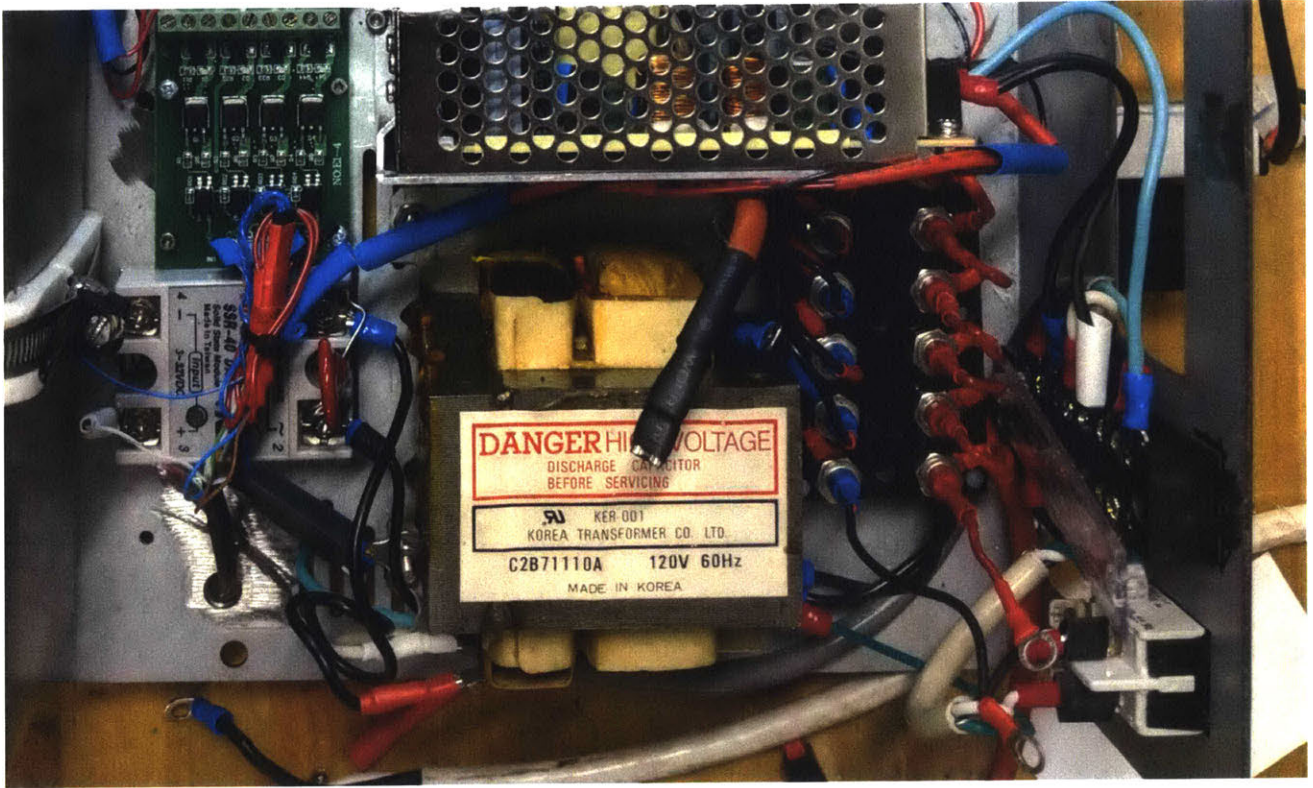

Figure 14: Closeup of the high-voltage power supply and bridge rectifier.

A combined 12v/5vDC Lambda TDK switching power supply provides power to all logic, charging, and discharge drivers. The 12v rail also supplies the case-cooling fan as well as the SPDT deadman switch on the bleeder resistor network.

In early iterations, the microcontroller was also housed within the main device and tethered to a small laptop via FTDI cable. Very early single-output channel iterations also used non-opto-isolated SCRs as used in the original Magstim, but the lack of electrical isolation would often lead to the destruction of the microcontroller, as the high voltage discharge would find a way back to the logic board. After the release of the “magic blue smoke” from one too many Arduino

Unos, all logic and switching was opto-isolated from any part of the high voltage charge or discharge path.

The main storage capacitor consists of a single 190 μ F, 3000v pulse-discharge capacitor made by General Atomics. It is perhaps, besides the inner sheet-metal case, the only original component remaining from the cannibalized Magstim. Its capacitance and voltage capabilities became the known values upon which all other values would be calculated.

Attempts were made to design custom pulse shapes utilizing high-current IGBTs coupled with protective flyback diodes. This train of inquiry was soon halted as it became clear that not only do IGBTs dislike being pulsed at 10 times their rated single-pulse specification, they are also extremely sensitive to extremes of di/dt and dV/dt , leading to self-firing and shorting. A self-firing event when charging up a capacitor to 2000v is quite a surprise, and not one this investigator would like to repeat. Attempting to switch off an IGBT at the height of the discharge can also lead to a “latching” effect, in which the IGBT will be unable to remove the charge from its gate and behave more like an SCR until its holding current drops below a certain threshold. Often the IGBT will just short out altogether. At \$1500 for an IGBT capable of handling 10kA of current, and two identical IGBTs needed per output channel to protect them from overcurrent, this quickly raised the price of output switching alone to \$12,000. This was not a defensible solution.

However, a solution using early 20th-century technology presented itself in the guise of a triggered spark gap. Many extremely high-voltage devices—especially those also coupled to extreme high-current needs, such as ignition devices, protective devices, high-speed photography, and the detonation of nuclear devices—still utilize spark gaps to this day.

At its simplest, a spark gap is an arrangement of two conducting electrodes separated by a gap usually filled with a gas such as air. When a potential between the conductors exceeds the breakdown voltage of the gas between them, a spark is formed, which ionizes the gas and radically drops its resistance. Current can then flow and will continue to do so until it drops below a holding current, at which time the ionization will cease and the resistance will be restored. Spark gaps behave like SCRs as well, but can be switched off before the holding current drops by “quenching” the gap and removing the ionized gas mechanically.

While a spark gap is normally controlled by precisely separating the distance of the electrodes to just under the voltage needed to fire the gap, in our case we needed more precise control and assurances against self-firing. For these specifications, we utilized a “triggered” spark gap configuration, in which the main gap is set much wider than the highest voltage to which the system would ever be charged, and a smaller secondary gap at the base of one electrode would be ignited using an extremely high-voltage, low-current spark provided by a minute step-up transformer and a Cockcroft-Walton voltage multiplier. This trigger gap would ignite a spark between the electrodes of the main gap, thereby lowering the electrical resistance, and the pulse from the capacitor would be discharged through the main gap. The trigger gap is fired for less than 50ms, and was sufficient to begin the cascade that would fire the main gap cycle.

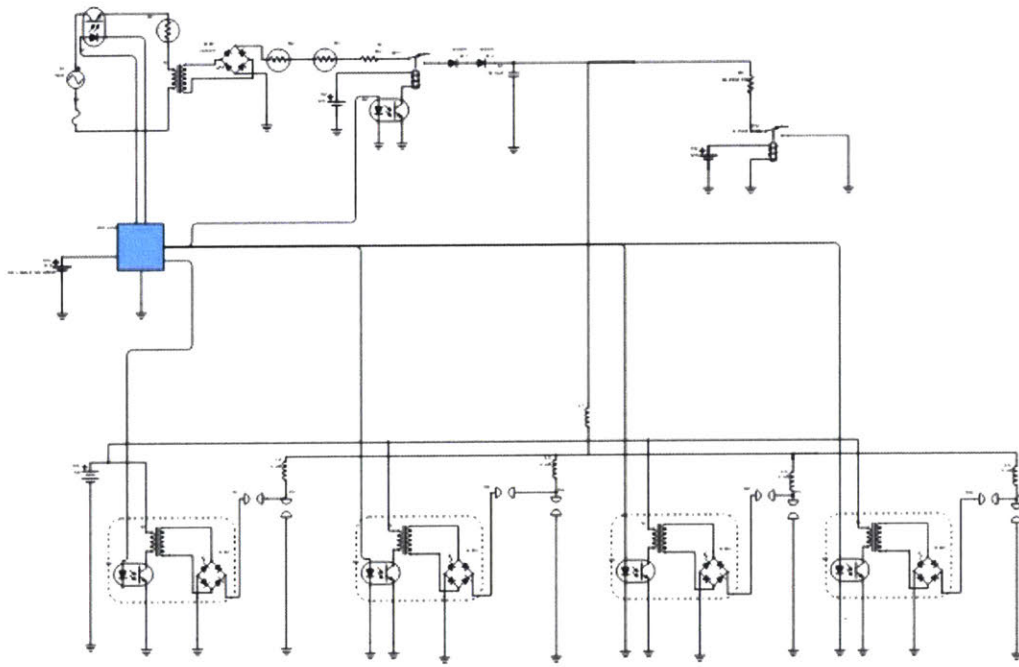

Figure 15: Schematic of Ono-Sendai Cyberspace 1.

Panel Controls and Indicators

The device began its life as a commercial Magstim Rapid 2, which upon deactivation was harvested for parts, with its outer shells and inner cases retained for use. The main deck was originally monolithic, containing both the charging and discharging circuits, unlike the commercial Magstim, which breaks out all charging circuitry into a separate but attached and matching deck.



Figure 16: Original configuration of Magstim Rapid 2



Figure 17: Front view of Ono-Sendai Cyberspace 1

The Ono-Sendai Cyberspace 1 contained the original indicator lights from the Magstim Rapid 2 upon which it was based. The main power switch and fusing mechanism were retained on the top right rear of the case and the “armed” indicator was on the left front of the deck is still visible. A design choice was also made to retain the original MIT “Deactivation” sticker, to alleviate any concerns about property usage.

The Magstim user interface was typically a low-resolution LCD touchscreen device running an embedded OS, allowing all charging and pulse train parameters to be entered before the system would arm itself. The display also contained pulse-output information similar to an oscilloscope.

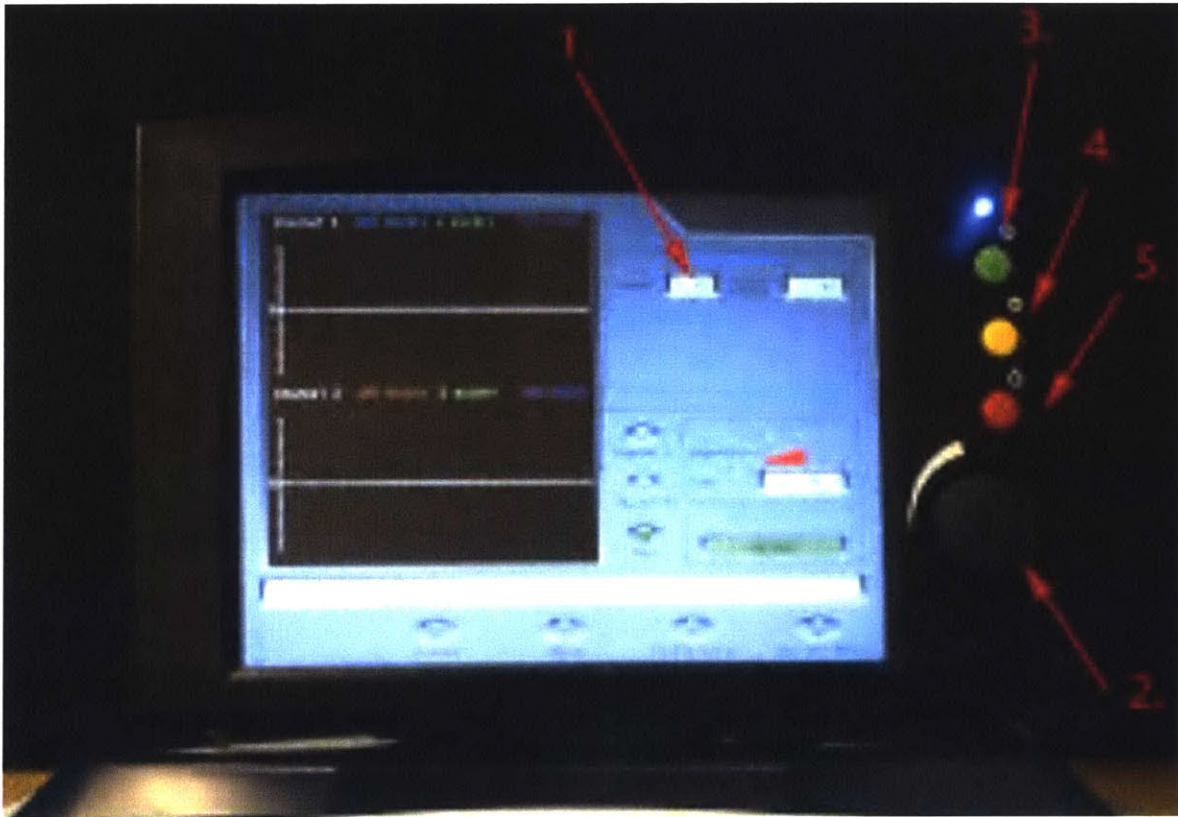

Figure 18: User interface of the Magstim Rapid 2.

The initial development versions of our device utilized a serial connection via USB to the microprocessor controller embedded in the deck. Similar control parameters, charging cycles, and discharge options could be entered via serial monitor.

Coil Design and Fabrication

TMS coil design is a strange cross between engineering and witchcraft. So much of the entire system can be constrained by the need for a particular coil size or focality, a minimum penetration depth, a specific pulse duration, or a peak magnetic field. Oftentimes all of these variables are necessary but are in opposition to each other and the basic laws of physics. Pick any three and be prepared to compromise. Small, deep, and powerful? Pick any two. Given the further constraint of a fixed initial capacitance, the voltage, inductance, and resistance determine the discharge behavior of the coil as they would for any damped resistance-inductance-capacitance (RLC) circuit.

Again, to naively maximize capacitance and peak magnetic field is a fool's errand and all elements must be tuned to achieve the necessities of a particular use case.

In its most basic guise, an inductive coil with radius b , the magnetic field along a line perpendicular to the coil and through its center is proportional to:

$$B_z = \frac{\mu_0}{2} \cdot \frac{NI}{b} \left(1 + \frac{z}{b^2}\right)^{-3/2}$$

where z is the distance from the coil along the central axis.

N is equal to the Number of turns of the coil,

I is equal to the current density,

And μ_0 is the permeability of free space.

Should you wish to calculate the flux density in Tesla at any area off-axis, the mathematics become quite complex, involving elliptic integrals of the first and second kind and for which there is no closed form:

$$B_{r_c}(r_c, \varphi, z) = \frac{\mu_0 I_o}{4\pi} \frac{(z - z_o) k_c}{r_c [r_c a]^{1/2}} \cdot \left[-K(k_c) + \left(1 - \frac{k_c^2}{2}\right) \Pi\left(k_c, -k_c^2, \frac{\pi}{2}\right) \right]$$

or equivalently,

$$B_{r_c}(r_c, \varphi, z) = \frac{\mu_0 I_o}{2\pi} \frac{(z - z_o)}{r_c [(r_c + a)^2 + (z - z_o)^2]^{1/2}} \cdot \left[-K(k_c) + \frac{r_c^2 + a^2 + (z - z_o)^2}{(r_c + a)^2 + (z - z_o)^2} \Pi\left(k_c, -k_c^2, \frac{\pi}{2}\right) \right]$$

Luckily, for most TMS use cases, we are concerned with finding the peak magnetic flux density at a known z-depth from the plane of the coil and at a focality directly above the last outer winding of the coil or, usually, where the outer windings of two coils, wired in series but with counter-rotating current directions meet. This coil configuration is often referred to as a “figure-of-8” or a “butterfly” coil. Seen below is the patent illustration and x-rays of several commercially available butterfly coils.

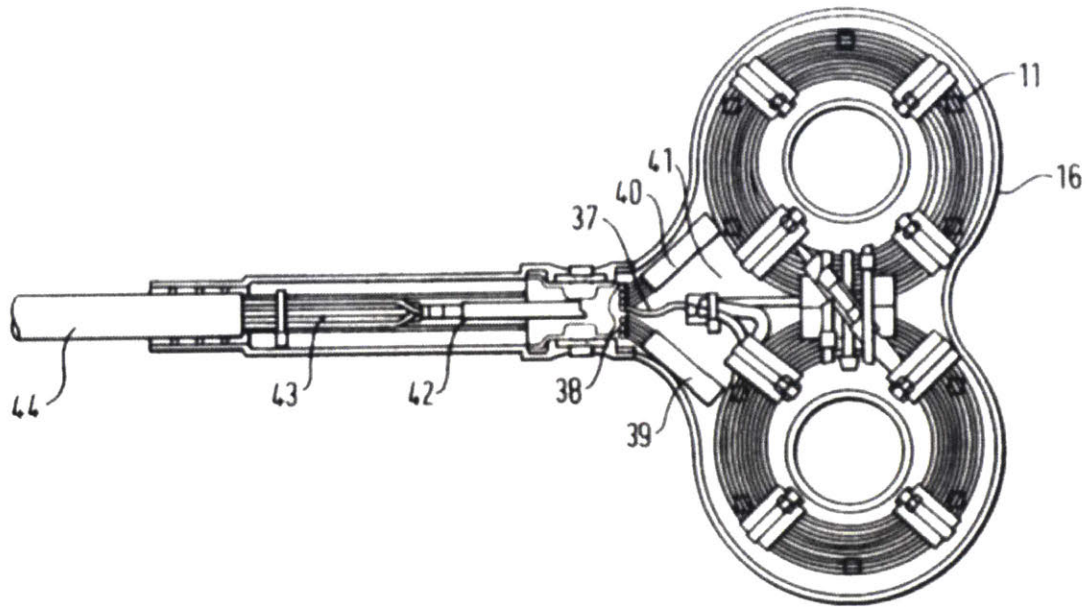

Figure 19: Patent illustration of Magstim 70mm "butterfly" coil (Mould 2001).

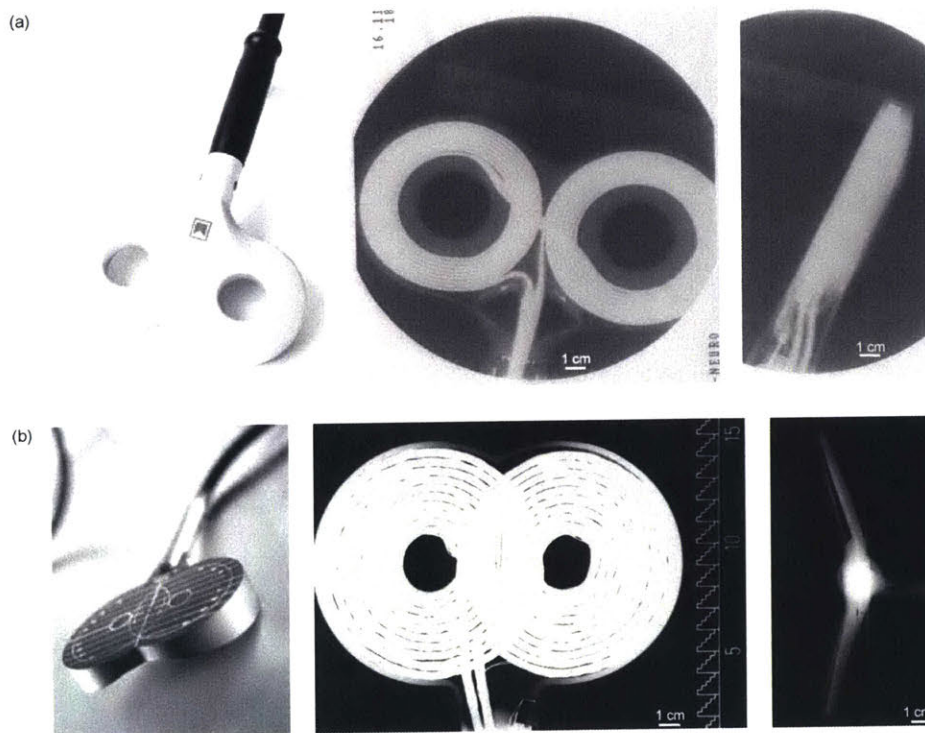

Figure 20: X-ray of commercial Magstim and Medtronic figure-of-8 coils (Thielscher and Kammer 2004).

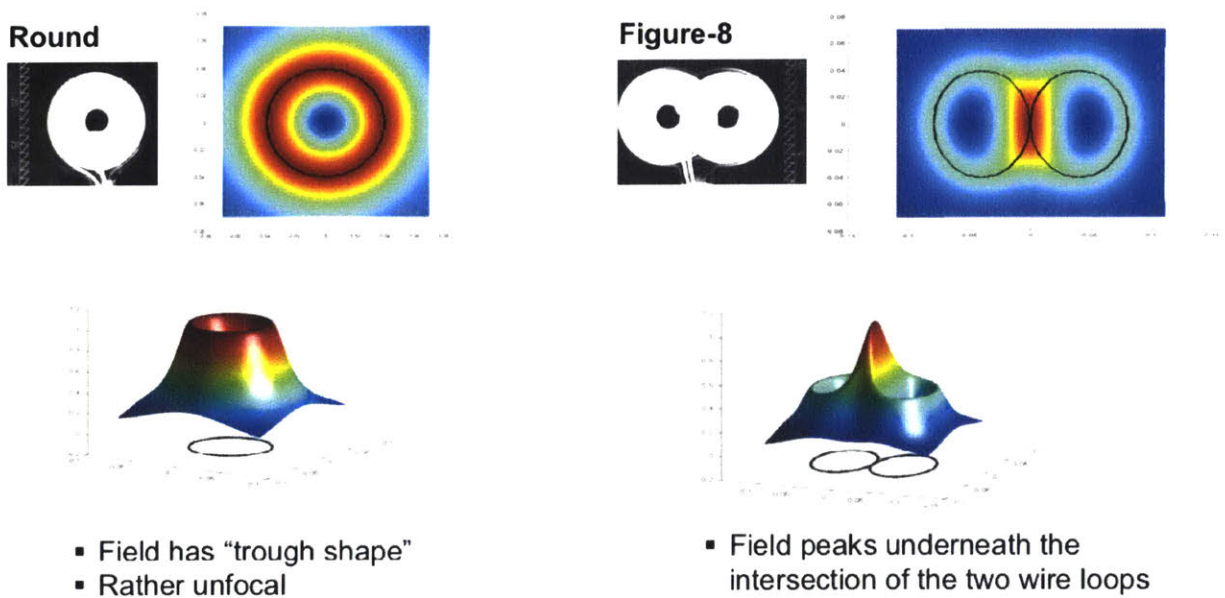

Figure 21: The electric field induced in a homogeneous conductor, calculated in a plane parallel to the coil plane (Thielscher and Kammer 2004).

Below you can also see typical coil diameters (inner and out), wire gauges, and other configurable information of the most commonly available coils.

Table 3.1: Parameters of commercial figure-8 coils

Mfr/Model	#Turns	ID	Mean	OD	Overlap	Wire Size	Angle
Magstim 70 mm	9x2	5.2 cm	7.0 cm	8.8 cm	0.0 cm	1x7mm	0°
Medtronic MC-B70	10x2	2.4 cm	6.6 cm	10.8 cm	4.2 cm	3.5mm(#8)	34.5°
MagVenture CoolB70	11x2	2.3 cm	5.95 cm	9.6 cm	3.6 cm	3x12mm	30.0°
MagVenture MC-B70	10x2	2.7 cm	6.2 cm	9.7 cm	3.5 cm	3x6mm	30.0°

One should note that most of the coils available attempt to be a “one-size-fits-all” of coil design, used for both deep-brain penetration for therapeutic use or for more shallow functional mapping, such as phosphene-induction studies. While coils of this size ensure dependable penetration, the

focality point between the coils, as well as the overall cortical area that could possibly be activated, is quite large.

For our use, we wished only to attempt to activate neurons in the V1 and V2 area of the occipital lobe, and ideally, only those most dorsal of foveal region of the retinotopic map. Stimulating any more of the hypercolumn would lead to a phosphene occupying too large a portion of the visual field. With the eventual goal of turning a phosphene into a pixel, we constrained the depth of our coil penetration to reach only the neurons we desired. This allowed us to shrink the coil diameter, which changes many of the other variables and so compromises, again, needed to be made. It was also decided that an array of smaller coils could be built into a helmet or head-rest of a car, allowing for the separate firing of any two of the coils in the array to create, at the time of firing, a single butterfly-type coil.

Initially, an array of very small coils was constructed and tested. Building on the work of David Cohen and B. Neil Cuffin (1991), we fabricated coils as small as 10mm. While coils of this size exhibit the extremely small focality we desired, they simply will not penetrate with any adequate power to the 1.7cm depth that is the average thickness of the human scalp and skull in the occipital region. Many focalities could be packed tightly together, but one simply cannot overcome the inverse-square law. For now, it remains a fundamental limitation of the universe in this field of endeavor.

We sourced samples of a rectangular braided Litz wire from Mehran Talebinejad. The wire “...used in this work is comprised of 2500 ultrafine wires, rated for high currents and voltages necessary for magnetic stimulation (10kA, and 3kV). The wire is only 7.3mm wide and 0.9mm thick making it amenable to tighter windings yielding high magnetic fields with a small coil diameter, and reduces coil heating issues. The coil is 3.1cm in diameter and provides a magnetic

field higher than the smallest available commercial coil despite being 40% smaller”

(Talebinejad, Musallam, and Marble 2011).

These specifications seemed ideal, as 31mm diameter would allow us pack up to seven or more coils over the visual cortex, with multiple focalities over the same region of the retinotopic map.

A duplicate of the Talebinejad coils were constructed. He notes:

Available Gaussmeters are not capable of measuring the magnetic field of a coil generated by a pulsed current in a few μs . It is also not possible to prolong the duration of the pulse with a current of a few kA. To compare the coils, we measured the magnetic field surrounding the coil due to a small current in the steady state. The transient current and rise time of the first resonance are determined by the inductance and the capacitance of the coil and the discharge system respectively. Inductance of this coil is 15 μH , close to commercial coils and the first resonance duration is shorter than 100 μs . As the magnetic field is directly proportional to the current in the coil, results are readily scaled to realistic current values

—(ibid).

His results are seen below:

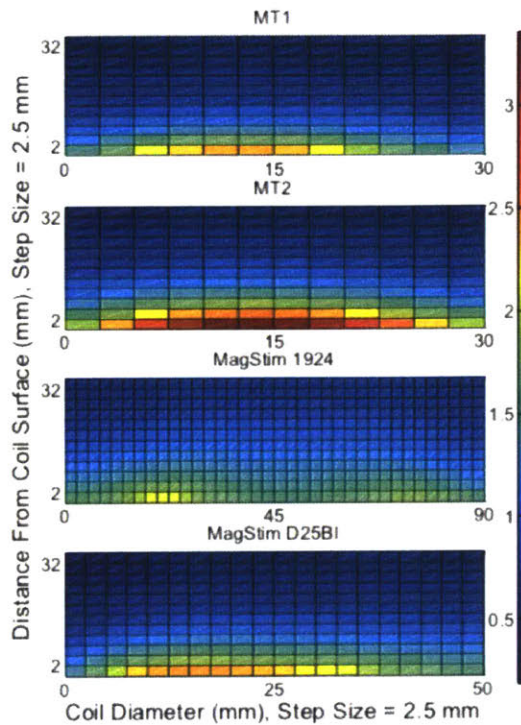

TABLE I. SUMMARY OF COILS' SPECIFICATIONS

Coil type	MT1	MT2	1924	D26BI
Diameter (cm)	3.1	3.1	9	5
# of turns	12	12	6	6
# of layers	1	2	1	1
Max. magnetic field (Gauss)	2.409	3.363	2.400	2.470

Figure 22: Talebinejad results (2011).

The MT2 is a double coil in a stacked Helmholtz configuration and Talebinejad's results indicate a peak magnetic field of 3.363T, once "scaled to realistic current values."

Finite element analysis was then undertaken using the Finite Element Magnetic Modeling package, simulating a pair of 30mm coils, overlapped as well as in the traditional butterfly configuration.

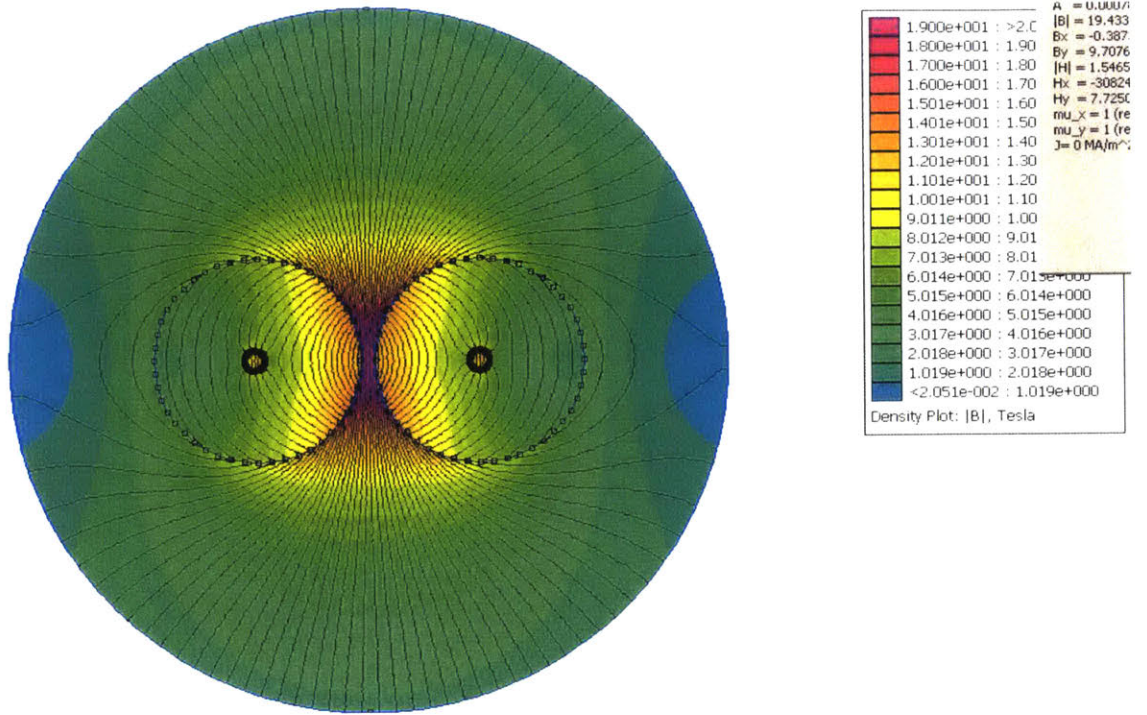

Figure 23: FEMM 30mmButterflyCoil 10kA 6.6kHz

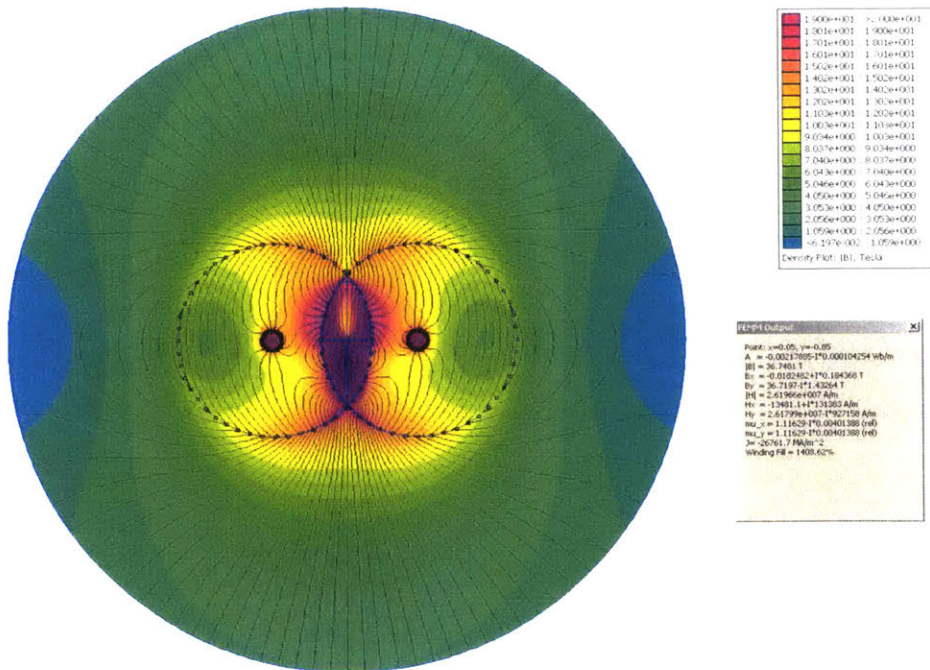

Figure 24: FEMM 30mmOverlappedButterflyCoil 10kA 6.6kHz

FEMM simulation indicated that fields of 2.5 to 3T would be possible given a 10kA pulse for a set of 30mm coils.

We had only a finite amount of the exotic Litz wire and would need all of it for testing and eventual construction of the array. Several 31mm coils matching Talebinejad's were fabricated.



Figure 25: Initial 30mm Litz wire test coils.

Stripping and soldering Litz wire is unlike working with common magnet wire, in that the internal varnish insulation must be removed from every one of the 2500 strands without damaging them. Common abrasion techniques cannot be used. Litz wire must be stripped using a 400C dip bath of pure sodium hydroxide, then neutralized in citric acid, and finally washed with distilled water and immediately dipped in a 400C solder pot to ensure the solder wicks evenly

between all strands and no oxidation can take place before the solder is applied. All work must be performed in a fume hood.

Below are several images of completed 30mm coil arrays, including the first multi-channel array. Several tests driving a known mass were used to test the coils at increasing voltages.

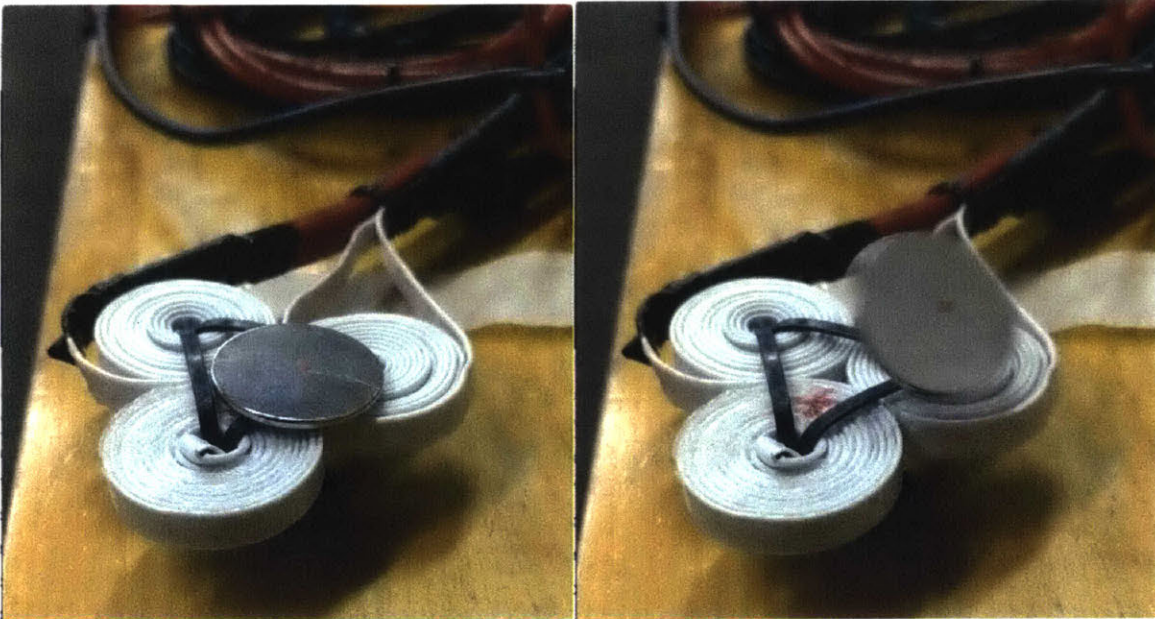

Figure 26: Measuring height of magnet propelled by 30mm Litz wire coils.

Finally, ferrofluid was filmed using a highspeed camera (120fps) to allow for a visualization of the focality point beneath the coil's edge.



Figure 27: Ferrofluid visualization of butterfly focality filmed at 120fps (8.33ms).

One can easily see the hourglass-like shape indicated by the FEMM simulations, as the flux focuses not in a perfect circle but in a line that falls off toward the center of each coil. The time between each successive frame of this clip is 8.33ms, and we note that the height of the pulse is already settling back down by the time this frame was taken. Several other video clips included the wave raising high enough to splash the lid of this 15mm deep petri dish.

Testing continued, but eventually, given the small amount of coil material at hand, the investigator decided that although a 30mm coil could handle 10kA, the depth penetration was likely to be barely adequate. It was decided to expand the coil size to 50mm, or a 25mm radius. This was done for two main reasons: First, to ensure adequate penetration of the occipital lobe and to ensure there was still adequate B-field strength at that depth. Second, citing several phosphene studies carried out using a Magstim 70mm coil, the investigator noted that most phosphene evocation begins by choosing a spot 2cm to the right and 2cm above the landmark of

the inion of the skull. Search patterns tend to work outward from there. A set of 50mm coils in an H-bridge configuration would place a focality at 2.5cm in each direction from the inion. We determined that four target locations, each equidistant from the inion, one each above and below the calcarine fissure, would give us the greatest chance of success for the largest number of subjects

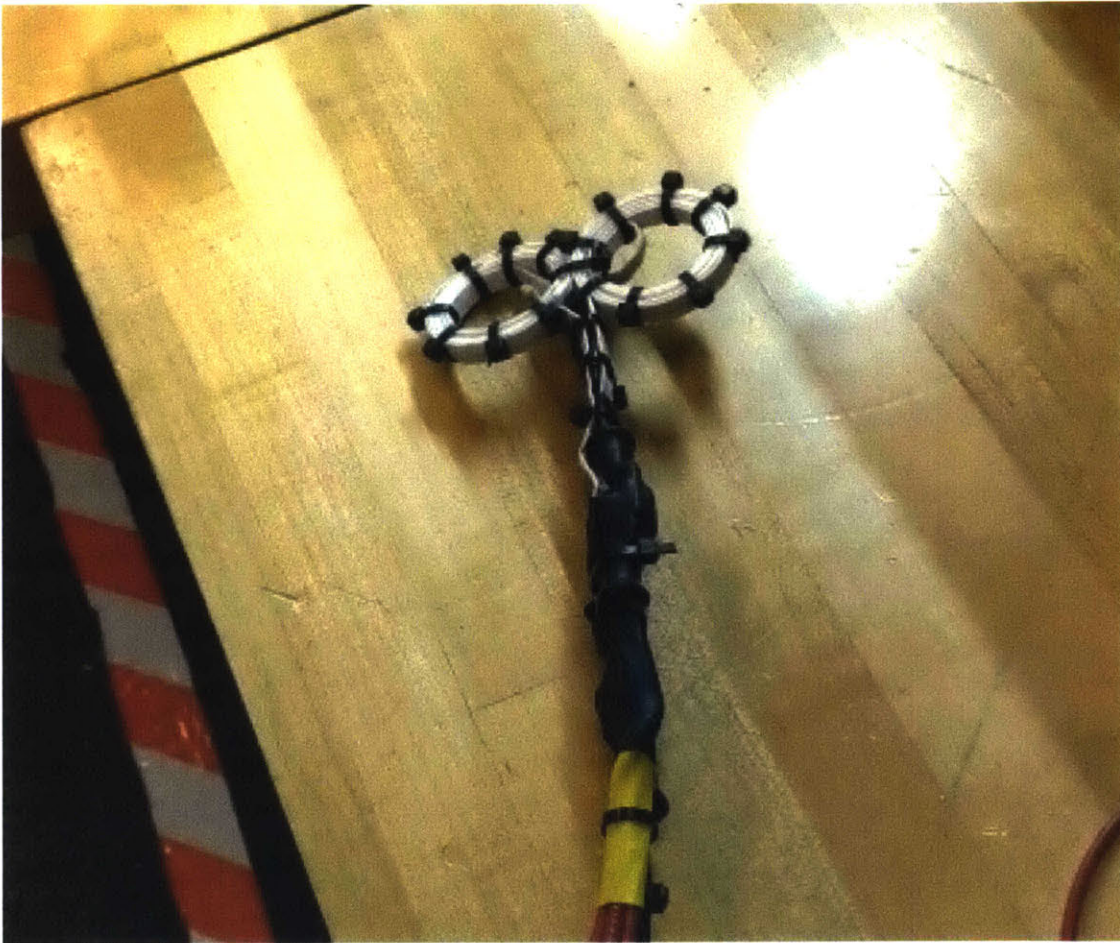

Figure 28: First of the 50mm coils in butterfly configuration.

Once a final coil radius had been settled on, work progressed to calculate the precise number of windings to provide maximum field strength but still within the proper pulse duration. Several online tools are available to determine and simulate these parameters.



Inductor Simulation

This is a Java simulation of an air-core inductor. You should see an applet (below) with slider controls to select the coil's dimensions and wire size. (Trouble? See [below](#).) Note this is only the coil and does not include a projectile.

Number of turns =	8 turns	Inductance =	0.004 mH
Winding density =	6.0 turns/cm	Resistance =	0.009 ohms
Turns per layer =	4 turns	Wire length =	1.13 m
Number of layers =	2 layers	Wire weight =	0.02 kg
Wire diameter =	1.67 mm		

How to Calculate Inductance

This program calculates inductance using Wheeler's Formula:

$$\text{Inductance } (\mu H) = \frac{0.8(NA)^2}{6A + 9B + 10C}$$

Figure 29: Inductor simulation by Barry Hansen, available at <https://coilgun.info/mark2/inductorsim.htm>.

With capacitance fixed and resistance minimized, inductance becomes the driving variable in the discharge behavior. The total inductance can be calculated fairly accurately based on the physical winding parameters. A large number of turns will increase the peak B-field but is antagonistic to pulse length. Keeping pulse rise time within the time required to fire the neuron requires a trade off in number of turns and total inductance.

An online JavaScript tool developed by Barry Hansen (available at <http://coilgun.info>) for modeling the behavior of the RLC discharge circuit using coil parameters and calculating peak current, peak B-field, and B-field a fixed distance from the coil was used to tune all final parameters.

v1.2

<<<
Time for Zero Crossing Pulse
>>>

Cap	100 us	200 us	300 us	400 us	500 us	600 us	700 us	800 us	900 us	1.0 ms
39 uF	26.0 uh	104 uh	234 uh	416 uh	649 uh	935 uh	1.27 mh	1.66 mh	2.10 mh	2.60 mh
47 uF	21.6 uh	86.2 uh	194 uh	345 uh	539 uh	776 uh	1.06 mh	1.38 mh	1.75 mh	2.16 mh
56 uF	18.1 uh	72.4 uh	163 uh	289 uh	452 uh	651 uh	887 uh	1.16 mh	1.47 mh	1.81 mh
68 uF	14.9 uh	59.6 uh	134 uh	238 uh	373 uh	536 uh	730 uh	954 uh	1.21 mh	1.49 mh
82 uF	12.4 uh	49.4 uh	111 uh	198 uh	309 uh	445 uh	605 uh	791 uh	1.00 mh	1.24 mh
100 uF	10.1 uh	40.5 uh	91.2 uh	162 uh	253 uh	365 uh	496 uh	648 uh	821 uh	1.01 mh
120 uF	8.44 uh	33.8 uh	76.0 uh	135 uh	211 uh	304 uh	414 uh	540 uh	684 uh	844 uh
150 uF	6.75 uh	27.0 uh	60.8 uh	108 uh	169 uh	243 uh	331 uh	432 uh	547 uh	675 uh
180 uF	5.63 uh	22.5 uh	50.7 uh	90.1 uh	141 uh	203 uh	276 uh	360 uh	456 uh	563 uh
220 uF	4.61 uh	18.4 uh	41.4 uh	73.7 uh	115 uh	166 uh	226 uh	295 uh	373 uh	461 uh
270 uF	3.75 uh	15.0 uh	33.8 uh	60.0 uh	93.8 uh	135 uh	184 uh	240 uh	304 uh	375 uh
330 uF	3.07 uh	12.3 uh	27.6 uh	49.1 uh	76.8 uh	111 uh	150 uh	197 uh	249 uh	307 uh
390 uF	2.60 uh	10.4 uh	23.4 uh	41.6 uh	64.9 uh	93.5 uh	127 uh	166 uh	210 uh	260 uh

Select a definition of the time period:

Time for Half Power Pulse

Time for Zero Crossing Pulse

Time for One Full Cycle

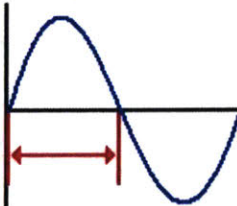

Read the inductance in the table above, or enter your custom values here:

Capacitance (uF):

Time (usec):

Inductance:

Figure 30: Determining inductance for a known capacitance and time constant, using a simulator developed by Barry Hansen, available at <https://coilgun.info/mark2/timesim.htm>.

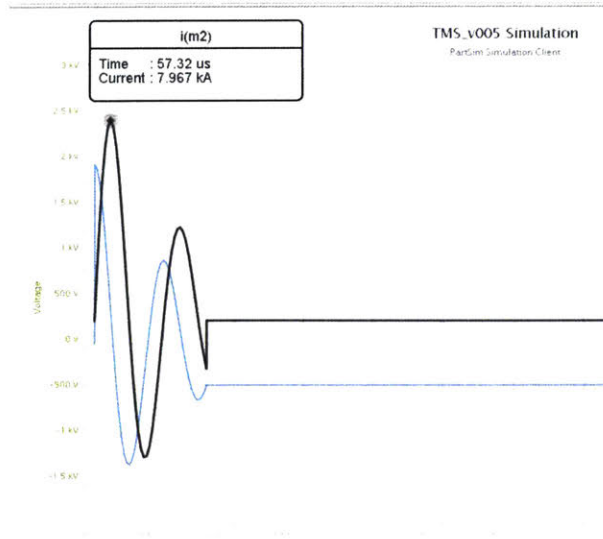

Figure 31: SPICE simulation of voltage and current discharge curve. Screenshot from <https://partstim.com>.

Finally, a search coil was placed on the array to confirm that the pulse duration was within operational expectations.

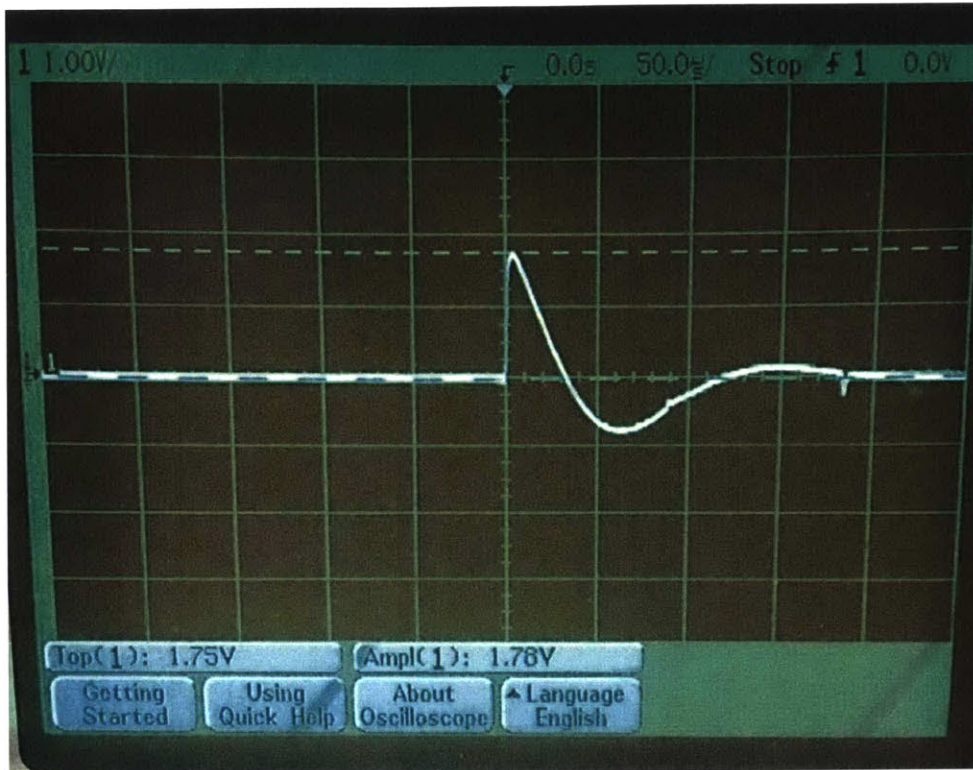

Figure 32: Biphasic Damped polyphasic output waveform from search coil.

The positive half-cycle and the negative half-cycle can be seen through the spark gap, which, like an SCR, remains active as long as sufficient current flows. Stray resistance from the system helped the dampen the discharge into a true biphasic wave. Care was taken not to add any additional resistance, as the system could become overdamped into a pure monophasic output, decrementing the probability of maximum membrane depolarization based on neuron orientation.

A full set of coils were hand-wound and molds were milled using the Shopbot in the Center for Bits and Atoms (CBA) shop at the Media Lab.

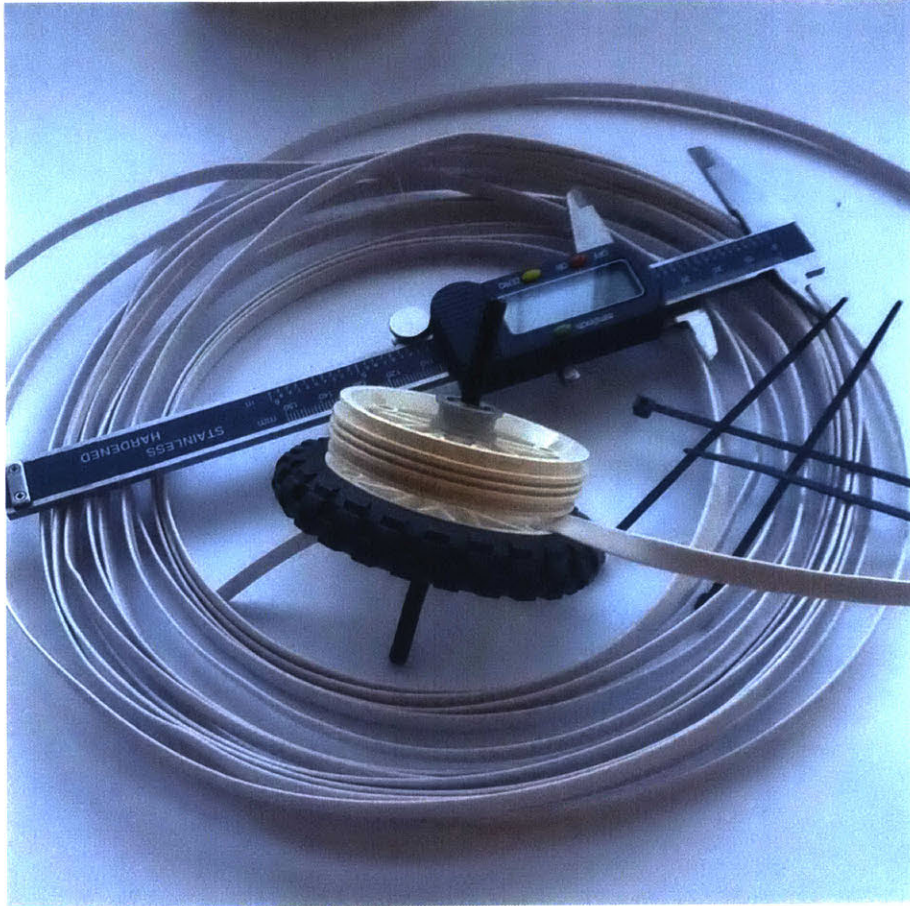

Figure 33: LEGO Mindstorms-based coil-winding jig.

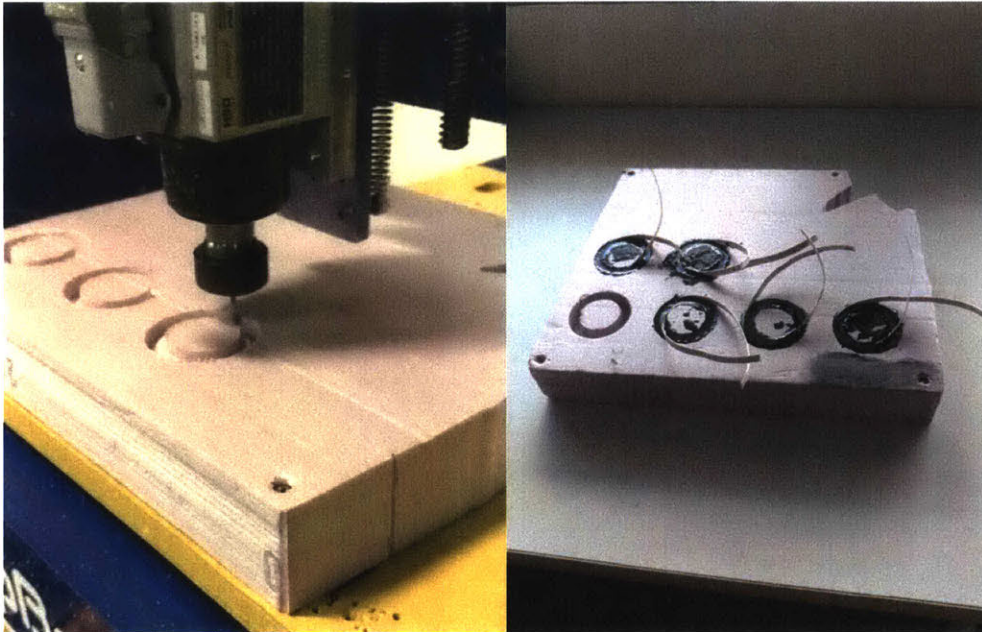

Figure 34: Milling and thermal epoxy potting of coils.

The coils were de-molded, stripped, solder-lugged, and wired together into the H bridge array.

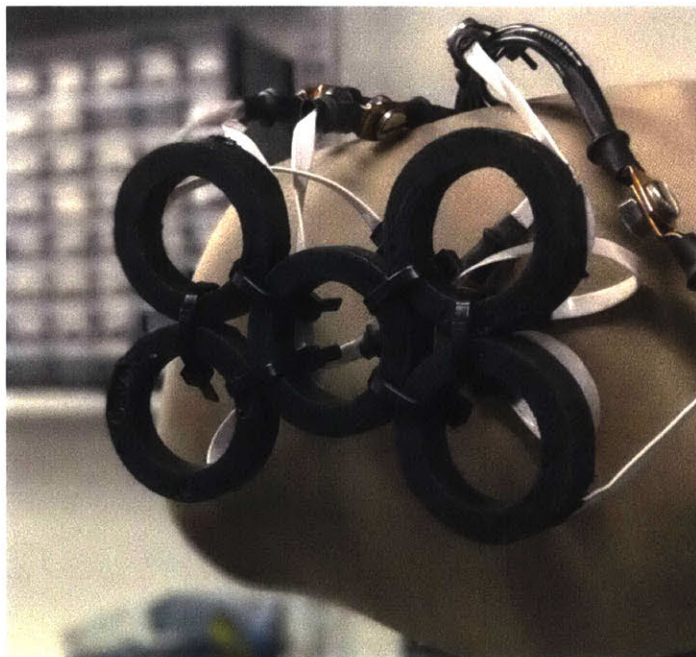

Figure 35: H bridge array in vehicle headrest orientation.

The coil array was then further insulated and installed in the wearable helmet,



Figure 36: Wearable array with isolation hood for dark adaptation.

After a coil-failure event after the start of clinical trials, we determined that Litz wire was simply not sufficient to withstand 10kA pulses; it was eventually replaced with a multi-strand set of #14AWG copper magnet wire formed into a “ribbon” similar in height to the Litz wire. As 14 gauge is slightly thicker than the Litz wire, a few windings had to be sacrificed to fit the new array within the original coil pack, but the overall induction and pulse duration remained similar.

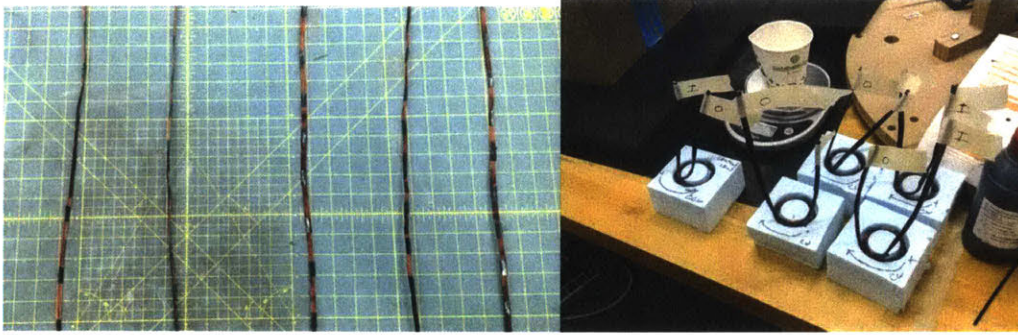

Figure 37: Ribboned #14 AWG and re-potting in epoxy.

Software Design

All switching, logic, feedback, and sensing were originally controlled using a commercial Arduino Uno, which was replaced with an Arduino ATmega 2560 rev 3 when the number of indicator lights and input controls grew too numerous for the Uno to host.

Our UX design functionality was originally modeled on the Magstim's LCD touch display, but we substituted a small Asus Eee PC running the Arduino IDE and communicating with sensors, relays, and switches via the serial monitor over USB. While this configuration worked well initially, the addition of the spark gaps created a situation in which, despite all attempts at shielding and attenuation, the electromagnetic energy of the spark gap, functioning like a Marconi transmitter, would couple into the USB cable and create a voltage spike high enough to reset the Arduino. Should this reset happen before the switching of the spark gap was complete, it could—and several times did—lead to a condition in which the smaller trigger gap would continue to fire and the microcontroller would need to be power cycled to quench the gap.

After several attempts to solve this issue, the USB cable was eliminated and all charge parameters, pulse trains, and other UI functions were hard-coded into the microcontroller and

controlled by a set of physical buttons. Only a 5v power and signal cable, fabricated from a shielded, twisted-pair ethernet cable, connected the main device with the control box. The control box provided grounded shielding for the Arduino, and with the combination of the twisted-pair cable and its shielding, the microcontroller was no longer susceptible to reset. The control box, in addition to housing and shielding the Arduino, also hosted a series of power, warning, and state-control buttons.

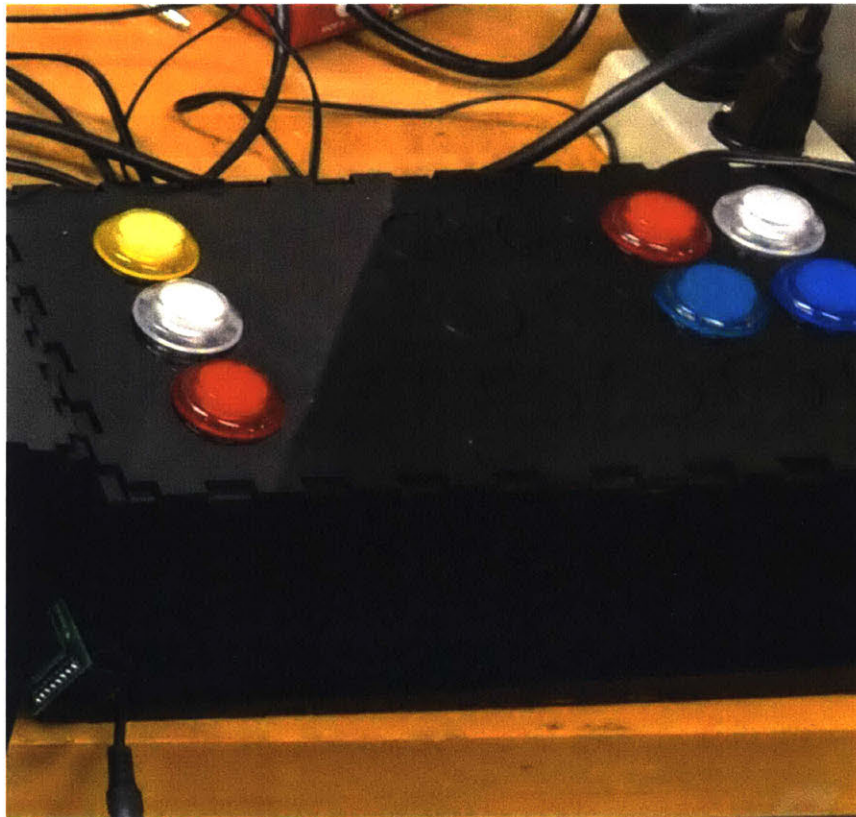

Figure 38: Shielded control box with arcade style buttons.

An off-the-shelf digital multi-meter was attached at all times as a safety feature, to read the voltage level on the capacitor in real time, and ran from its internal battery with no opportunity for the high-voltage discharge to find its way back to any fragile, low-voltage logic control. The commercial digital multimeter (DMM) had an internal impedance of 10M Ohm and, as another

safety feature, nine more 10M Ohm resistors were wired in series with the positive probe, providing additional current limiting and allowing the DMM to safely sense up to 10 times its normal range. A highly visible note was placed on the DMM to warn any unfamiliar users that, with this particular set of probes, the reading on the LCD display of the DMM should be multiplied by 10 to arrive at the correct voltage rating.

CHAPTER 4: CLINICAL TRIALS

The purpose of this study was to test the targeted evocation of magnetophosphenes in the visual cortex. In particular, we investigated whether one of four specific areas of the visual cortex (V1) can be stimulated to place a magnetophosphene in a predictable location within the subject's visual field. Previous TMS studies have shown evocation of phosphenes in a binary manner with subjects reporting the presence or absence of a phosphene but not targeted to a specific location (see, for example, Grau et al. 2014; Losey et al. 2016; Jiang et al. 2018).

In this study, we used single pulses, separated by at least one second, and an array of coils composed of five rings, each 50 mm in diameter, arranged in an H bridge-like configuration. The central coil plus any single one of the outer coils can selectively be used to form an industry-standard figure 8-shaped coil. The figure 8 design allows for more precise spatial targeting than a single coil by summing the generated electric fields. The fields add synergistically only in a limited region of space where the coils meet. The H-bridge configuration allows the targeting focality to be transposed without physically translating any single set of coils. The coil is built into a wearable helmet, and weighs approximately 1kg.

Established TMS protocols were followed in all experiments undertaken. These protocols have been used in numerous labs around the world, resulting in thousands of publications. All of the stimulation protocols were within the safety guidelines of Simone Rossi et al. (2009) and Eric Wasserman (1998). When conducted within these parameters, adverse effects are very rare (see "Risks," below).

Procedure outline.

1) The goals and procedures of TMS research were thoroughly explained and informed consent was obtained from participants. The consent forms and other documentation are included in the Appendix.

2) Coil localization was performed based on location of the inion.

3) Testing with TMS was conducted.

Coil Localization. We localized coil placement using anatomical (scalp and skull) landmarks, specifically the inion—the external occipital protuberance. The coil array configuration and size in regard to the location of the inion places the focality of stimulation within V1 in the largest average of subjects.

Testing sessions. Subjects were seated comfortably in a chair in a darkened room, with a light-blocking measure over their eyes (a.k.a. the “isolation hood”), and initially with their eyes closed. TMS was used to briefly evoke neural activity in one candidate area of V1 and the subject was asked to report if and where they may have perceived a visual phenomenon. Some subjects were then retested with eyes open and/or without the isolation hood to ascertain whether the phenomenon is distinct enough to be seen under normal lighting conditions. During TMS, subjects and experimenter wore earplugs to protect inner and middle ear structures from the noise of the device.

Stimulation trains. During a given trial, subjects received one TMS pulse occurring within 250ms at a rate no greater than 1Hz. Several subjects also received sham stimulation well below the energy needed for neuronal activation to act as a control. The time between TMS pulses is limited by hardware to one second or more. This duty cycle was extended to allow for qualitative

description of any evoked phosphene, as well as the time it took to enter the data in the REDCap clinical software suite.

Phosphene threshold was assessed by initially choosing the coil pair at the location closest to 2.5cm dorsal and lateral from theinion and delivering three to four pulses at gradually increasing intensities until a phosphene was reported or the device's maximum charge was reached.

Stimulation strength. For each subject, single-pulse TMS stimulation intensity for the main experiment was individualized to the participant's phosphene threshold. Subthreshold intensities were used for sham trials to test for false positives, while suprathreshold intensities were utilized to raise the rate of phosphene perception. Note that the sound of the spark gap discharge at subthreshold voltages is indistinguishable from suprathreshold discharges, especially when, as was true in our study, hearing protection is worn. While all subjects were warned that they might feel the coils flex and "tap" them on the back of the head, none seemed to notice that the flexure was less during sham stimulation.

TMS testing sessions typically took less than 30 minutes of actual device time, but could take 45 minutes to an hour to properly screen participants and acquire informed consent. No experiment required more than one TMS session.

COUHES agreed with our assessment that our study was Not Significant Risk (NSR). The stimulation parameters have been shown to be safe (c.f. COUHES#0808002871) in cortical (Rossi et al. 2009) and cerebellar (Grimaldi et al. 2014) TMS. COUHES did request that we take advantage of MIT's Clinical Research Center (CRC) in Building 25, whose medically trained staff would meet all safety and first responder needs in case of any adverse event.

Adverse events (especially seizures) have been reported in both neurologically compromised and normal subjects after TMS. However, the stimulation protocols and parameters we used were

within the safety guidelines (Rossi et al. 2009; Wassermann 1998) under which adverse effects are extremely rare (see “Risks,” below). Regardless, in all testing sessions, a nurse or nurse practitioner was present should CPR or seizure management have been required. No adverse effects were reported throughout the entirety of the study. A small red mark on the forehead of subjects with head circumferences of greater than 60cm was noted, as this was the maximum size to which the helmet could be adjusted, and this sometimes led to a tight fit. This red mark faded within minutes of the helmet being removed. Subjects with a head circumference of 55cm or less reported no discomfort and their fit was adjusted using a set of foam spacers of differing thickness that could be added or removed as needed.

Inclusion/exclusion criteria. Subjects were healthy, normal individuals between 18 and 55 years of age, who had no significant neurological history, were not taking any substances which may interfere with normal brain function, and had normal or corrected-to-normal vision. In addition, based on the recommendations of “A Consensus Statement from the International Workshop on ‘Present and Future of TMS: Safety and Ethical Guidelines,’ Siena, March 7–9, 2008” (included as a supplement to Rossi et al. 2009), we utilized a questionnaire to exclude subjects for several safety-related reasons:

- Metal anywhere in the head, excluding the mouth. This includes cochlear implants and other neural stimulators. According to Rossi et al. (2009), this is the only absolute contraindication to TMS.
- Past severe head trauma, history of severe headaches, history of neurological disorders or brain trauma (e.g. stroke), increased intracranial pressure, past spinal surgery, spinal ventricular derivations, history of seizures or syncope, family history of epilepsy.
- Hearing problems or chronic tinnitus.
- Implanted medication pumps or infusers.

- Serious heart disease, cardiac pacemaker, or other electrodes inside the heart.
- Known or suspected pregnancy. A urine pregnancy test was administered by CRC personal for all enrolled female subjects during pre-screening.
- Sleep deprivation (less than four hours the night before).
- Currently using/taking any of the following substances/medications: Imipramine, amitriptyline, doxepine, nortriptyline, maprotiline, chlorpromazine, clozapine, foscarnet, ganciclovir, ritonavir, amphetamines, cocaine, MDMA (ecstasy), phencyclidine (PCP, angel's dust), ketamine, gamma-hydroxybutyrate (GHB), alcohol, theophylline, mianserin, fluoxetine, fluvoxamine, paroxetine, sertraline, citalopram, reboxetine, venlafaxine, duloxetine, bupropion, mirtazapine, fluphenazine, pimozide, haloperidol, olanzapine, quetiapine, aripiprazole, ziprasidone, risperidone, chloroquine, mefloquine, imipenem, penicillin, ampicillin, cephalosporins, metronidazole, isoniazid, levofloxacin, cyclosporin, chlorambucil, vincristine, methotrexate, cytosine arabinoside, BCNU, lithium, anticholinergics, antihistamines, sympathomimetics.
- Currently experiencing withdrawal from any of the following: alcohol, barbiturates, benzodiazepines, meprobamate, chloral hydrate.
- Had taken any of the following within one week of the testing session: Narcotics, stimulants (with the exception of caffeine), cocaine, LSD, marijuana.

Risks. The use of magnetic stimulation is an approved procedure for several clinical treatments. Although using transcranial magnetic stimulation in an “off-label” fashion could be considered an experimental procedure by the FDA, numerous studies involving stimulation parameters within the approximate range of the proposed research have been published in the past 15 years, and few serious adverse mental or health effects have been reported in normal, healthy subjects. The standard source for information on safety guidelines for TMS comes from “A Consensus

Statement from the International Workshop on ‘Present and Future of TMS: Safety and Ethical Guidelines,’ Siena, March 7–9, 2008” (Rossi et al. 2009). The two potential concerns with TMS arise from i) minor discomfort during the stimulation or its after effects, and ii) seizures induced by the stimulation. As previously noted, all of the study parameters were within the Rossi safety guidelines.

Discomfort. For many scalp locations, TMS feels like a sudden tap on the scalp accompanied by a clicking sound. For other locations, TMS can cause face, neck, or limb twitches. These twitches are generally not painful, but can feel odd or unpleasant. Strong TMS might produce a sensation of pain, but our device is power-limited and cannot attain this level of stimulation. We closely monitored subjects' comfort and requested them to tell us if the stimulation ever felt uncomfortable. Any subject who found the stimulation too uncomfortable, during sham, thresholding, or suprathreshold stimulation would have been excluded, although no subject ever complained of discomfort.

Occasionally, the trapezius can be stimulated if the focality of the stimulation is insufficiently deep, which can cause the muscle to contract. While this is not painful, it can feel odd or unpleasant. Care was taken when placing the coil array to eliminate this possibility and no trapezius contractions were reported.

A significant percentage of people (20–30 percent) undergoing TMS experience mild headaches, which are believed to be due to excessive muscle tension. In the case of a headache, participants would have been offered acetaminophen (Tylenol) or aspirin, which in most cases would promptly resolve the discomfort. No subjects complained of headache or requested acetaminophen or aspirin. The experimental procedure would have been immediately terminated

if anyone reported experiencing a headache severe enough that they no longer wished to participate.

Approximately 10–20 percent of people undergoing TMS experience neck stiffness and neck pain. This is believed to be due to the straight posture of the head and neck during the application of TMS. In the case of such an event, any participants would have been offered acetaminophen or aspirin to resolve the discomfort. The experimental procedure would have been immediately terminated if any subject reported experiencing discomfort severe enough that they no longer wished to participate. No subjects asked to terminate the study due to discomfort.

TMS produces a loud clicking noise when the current passes through the coil, and our custom device also uses a loud spark gap for output switching. Although it would have been very unlikely for this loud click to result in tinnitus and transient decreased hearing if no protection was used, we erred on the side of safety and required experimental participants and experimenters alike to wear ear protection devices that reduce the intensity level of the click and the spark to approximately 80dB. Animal and human studies have demonstrated that earplugs can effectively prevent the risk of hearing disturbances or discomfort due to TMS.

Risk of seizures. The risk of seizures in neurologically healthy subjects is low but not zero. This risk is greater from higher-frequency stimulation occurring over long durations (of many seconds or minutes), when stimulating over the motor cortex, and/or when stimulating at intensities well above motor threshold. Our protocols avoided these riskier situations and are within the established safety guidelines (Rossi et al. 2009; Wassermann and Zimmermann 2012). In Rossi et al., approximately eight instances of rTMS-induced seizures occurring within the previous 10 years were addressed. Of the four in which rTMS parameters were within the previously set guidelines (Wassermann 1998), three subjects were taking pro-epileptogenic medications, and

two of the instances may have represented non-epileptic events (i.e. syncope). Of four events with parameters outside the established safety guidelines, three of four instances of seizures occurred in patients taking pro-epileptogenic medications or following sleep deprivation, and one of the four cases may have represented a non-epileptic event (ibid.). These cases represent a very small fraction of tens of thousands of rTMS participants.

Risk of Fainting. Risk of fainting (i.e., syncope/pre-syncope) is also non-zero. The cause of TMS-associated vasovagal events are not completely understood and are likely attributable to the anxiety level of the participant rather than the induced electrical current. Our subjects were monitored closely by CRC staff and seated in a cushioned chair, in the CRC facility, to minimize the risk of falling should a syncope/fainting event occur. If these symptoms had occurred, TMS would have been stopped immediately and the subject assisted.

As described above, subjects were informed that they should report any discomfort and were free to terminate an experiment at any time due. Ear plugs were provided to prevent auditory discomfort and adverse effects on hearing. To minimize seizure risk, our protocols avoided the conditions that have been associated with seizures in the past (long-duration trains of medium and high-frequency rTMS, and stimulation intensities much higher than motor threshold). Nonetheless, for each subject tested, at least two experimenters were present in the room during the testing session. The CRC provided a clinical nurse trained in CPR and in seizure detection and management. Additionally, a fully qualified clinical nurse or nurse practitioner monitored all subjects continuously before, during, and immediately after the testing session. Subjects completed a side-effect questionnaire immediately before and immediately after the TMS.

In the unlikely event that a subject had had a seizure or showed any signs that a seizure might be imminent, the experiment would have been immediately halted, the clinical staff would have protected the person from injury by moving any sharp or hard objects from their vicinity, by cushioning the person's head if were are at risk of falling, and by quietly reassuring the participant.

No adverse events involving a subject occurred and a report to COUHES was not necessary

Data capture. All data was captured using the Research Electronic Data Capture system (REDCap), a web-driven, PHP tool that allows for custom forms, or “instruments,” offering conditional and branching logic, protocol order-of-operations checklists, timestamps, automatic follow-up forms and emails, and collective data export into convenient software packages such as Microsoft Excel, R, Matlab, or Python.

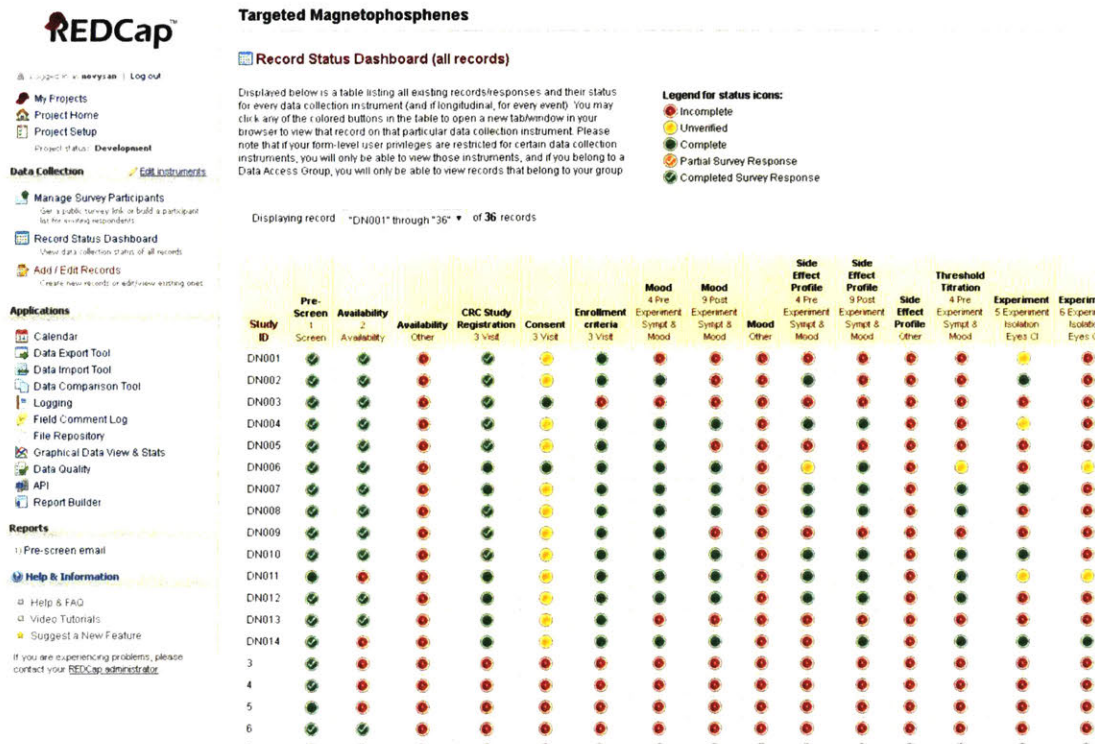

Figure 39: REDCap—Research Electronic Data Capture system.

The study ran for approximately two weeks in Building 25, at MIT’s Clinical Research Center, including a short break to access and repair a machine malfunction in the coil array that was discovered after the first subject.

Prior to the study, a recruitment email went out over the central Media Lab mail list, @ml-all; within 48 hours we recorded 38 validated and pre-screened responses for this uncompensated study.

Twenty subjects were further screened and scheduled to participate. An additional four subjects were eliminated prior to participation, at the discretion of the CRC staff, for health conditions that were not initially listed as contraindicated in our COUHES application, but which were felt, nonetheless, to be severe enough to eliminate the subject from participation. These conditions

included elevated blood pressures that might have indicated an underlying medical condition that could have been adversely affected by neurological stimulation, however unlikely. A total of 16 healthy subjects were eventually processed through our procedures.

Thresholding. With the subject seated upright, in a dark room, the initial phosphene threshold was assessed by choosing the coil pair at the location closest to 2.5cm dorsal and lateral from theinion and delivering 3–4 pulses at gradually increasing intensities until a phosphene was reported or we reached the maximum charge capacity of the device. This location, up and to the right—evoking a phosphene contralaterally in the lower left hemifield—is an industry-standard location to begin phosphene trials and is used in almost all studies initially. If a phosphene was reported, we recorded where the phosphene was located and at what voltage. If, as happened in 31 percent of our subjects, no phosphene threshold could be found using the initial coil pair, this process was repeated using other coil pairs, targeting the other three possible locations. If no phosphene threshold was found in any of the four possible locations, all data was noted, and the subject dismissed from the study. It is an interesting point that no subject who could not be thresholded by the initial coil pair was thresholded by any of the subsequent pairs. It seems an “all or nothing” pattern is involved, as will be discussed in the “Results” chapter. Successfully thresholded subjects immediately moved on to Experiment #1 and possibly Experiment #2.

Naivety. Many people have never encountered nor taken notice of the phosphenes that occur regularly throughout the day, whether retinal phosphenes emanating from electrical noise in the photoreceptors of the eye or cortical phosphenes in the visual cortex, which can result from standing up too quickly or receiving a blow on the back of the head. After the first few subjects, it became clear that it is difficult for naive subjects to recognize and distinguish phosphenes,

especially given that TMS can also induce involuntary eye-blinks, even when the eyes are already tightly closed, or other muscle contractions. Asking a naive subject to report the occurrence and location of a phenomenon which they've never seen before would lead to a great number of false negatives. After consultation with a team of experts at Beth Israel Hospital, and using an industry-standard method they employ, a small change was made to the protocol. During the pre-screening phase, we clearly articulated what a phosphene was and how it may appear, using many of the descriptions found in the literature. This qualitative description was used across all subjects and many subjects seemed relieved to have the phenomenon explained to them.

Attentional Cueing. In addition to requiring a qualitative description, asking a naive subject to report an unfamiliar phenomenon in what could seem to be a random location would also lead to a higher-than-average number of false negatives. Again, at the urging of Beth Israel, we altered the protocol to add an “attentional cue” as to where the phenomenon might occur. Since all subjects were thresholded using the “up-and-to-the-right” set of coils, all of them should have perceived the phosphene in the lower-left hemifield. We adopted a clock face metaphor for describing phosphene location and subjects were asked to stare straight ahead, with their eyes closed, but to concentrate their awareness on the field that would cover from 6 to 9 o'clock on a standard analog clock face. Again, this location was used across all further subjects.

Throughout the thresholding and experimental process, when assessing the occurrence of phosphenes, participants were instructed to respond verbally by stating “yes” if they definitely perceived a phosphene, “no” if they definitely did not perceive a phosphene, or “maybe” if they perceived something, but were unsure if it was a phosphene or some other sensation such as an eye-blink. A “maybe” response was not counted as a positive or negative report, but instead initiated a follow-up pulse until a clear positive or negative was announced.

Post-Threshold Experiment #1 and #2. If a threshold could be successfully located, that subject would move on to Experiment #1. Experiment #1 included searching for phosphenes in any of the four focality locations with the isolation hood down, but the eyes remaining closed as they were in the initial thresholding portion of the study. At this point, the subject had just experienced what was perhaps their first phosphene and was hopefully more familiar with the phenomenon. No attentional cueing was provided during this phase of the study, as it was a test of whether our device could target the individual location with enough accuracy to create a phenomenon, as well as whether the subject could perceive it. All discharges were at or above the subject's personal threshold, except for sham discharges used to test for false positives. As previously noted, study participants seemed to find sham and suprathreshold discharges audibly and kinetically indistinguishable.

If a subject scored better-than-chance on the number of true positives, they would advance to Experiment #2, which repeated all conditions of Experiment #1 but required the subject to keep their eyes open during the discharge and report any phosphene activity seen. Again, participants were instructed to respond verbally by saying "yes," "no," or "maybe," followed by a qualitative description of the phosphene. "Maybes" were not counted as positives. All data points for each discharge, their responses, voltages, coil pairs, clock-face locations, and qualitative descriptions we recorded into the REDCap instrument, with any special notes, suggestions, or interesting pre- or post-interactions being recorded in a dedicated field,

At no point did any adverse effect or subject discomfort require the termination of any session.



Figure 40: Device in use during clinical trials.

CHAPTER 5: RESULTS AND DISCUSSION

Overall, the study set out to discover whether we could place, first, a single bit of information into a subject's visual field at a known location and then, if successful, whether our device and coil array were sufficient to place a single bit of information without the attentional cueing provided during the initial thresholding phase of the study. A display system in which one must know where to look before one sees something is not much of a display system, but given the results that follow, we feel confident that training naive subjects on what to look for had a greater impact than directing them where to look. Not only were we able to evoke a basic phosphene in over 68 percent of the subjects, our success rate improves significantly for subjects perceiving and locating the phosphene in the correct quadrant or hemifield.

Results of the clinical trials, all experiments, and qualitative descriptors are listed below with discussion to follow.

Clinical Quantitative Results

Table 5.1: The number of subjects achieving phosphene evocation at the end of 2-week trial. n=16, df=1.

Subjects Tested	Observed	Expected	Chi Square Totals	p
Thresholded	11	8	1.125	
Non-Thresholded	5	8	1.125	
Totals	16	16	2.25	0.13

The observed number of subjects for whom we were able to evoke a magnetophosphene in a targeted location was 11 out of 16, $p > .05$ (Table 5.1).

Table 5.2: Experiment #1: The number of pulses correctly seen and placed with eyes closed. n=10, df=3.

Pulses	Observed	Expected	Chi Square Totals	p
True Negatives	4	04.00	0.0	
False Negatives	36	37.00	0.027	
False Positives	12	09.25	0.818	
True Positives	22	09.25	17.574	
Totals	74	59.50	18.419	*0.0036

The observed number of correctly perceived and located suprathreshold pulses with the subject's eyes closed was 22 out of 72 and was statistically significant, $p < .05$ (Table 5.2)

Table 5.3: Experiment #1: The number of pulses correctly seen and placed with eyes open. $n=6$, $df=3$.

Pulses	Observed	Expected	Chi Square Totals	p
True Negatives	0	00.00	0.00	
False Negatives	10	11.00	0.09	
False Positives	6	02.75	3.84	
True Positives	6	02.75	3.84	
Totals	22	16.50	7.77	** .05

The observed number of correctly perceived and located suprathreshold pulses with the subject's eyes open was 6 out of 22 and was statistically significant, $p = .05$ (Table 5.3).

Discussion

Although the sample size is small for the main thresholding experiment, evoking phosphenes in 11 out of 16 subjects is an encouraging result. While the p-value may fall above what is often considered to be statistically significant, that value should be lower given an interesting condition that came to light during the trials.

We had naively believed that phosphene sensitivity would be equal across the population, but after two subjects out of the first six were completely unable to achieve a threshold, we contacted our advisory team at Beth Israel to ask if they'd ever had subjects who seemed to be absolutely phosphene-insensitive. Much to our surprise, they responded that, yes, indeed, there is an entire portion of the population that does not appear to be evocable. A quick meta-study of the literature ensued, specifically searching phosphene protocols in which pre-screening methodologies were described and the non-thresholdable subjects were rejected. The proportion of rejected subjects quickly converged on approximately one-third, a number anecdotally supported by Beth Israel. Continued research finally revealed the following paper by Meister et al., which studied this proportion and unequivocally states:

Single pulse focal TMS does not elicit phosphenes in all normal subjects. The percentage of investigated subjects perceiving phosphenes varies across studies. Our results, along with those of Meyer et al. (1991) indicate that about two-thirds of the subjects tested with TMS report phosphenes. The mechanism underlying the *absence of phosphene perception in the remaining third is still unknown*

—(Meister et al. 2003) (*Emphasis mine*).

Further investigation of the literature also revealed that most phosphene studies pre-screen all enrollees and dismiss any phosphene-insensitive subjects. All trials are then continued using only phosphene-sensitive subjects. In fact, many programs running continuing phosphene studies have a collective pool of phosphene-sensitive subjects who are asked to return for new studies so as not to lose too much time in an initial pre-screen.

Additionally, unless testing a new device, these initial pre-screens are all completed using commercial devices such as the Magstim Rapid 2 or similar, thus ensuring known-adequate

power levels and depths of penetration. Had the investigators known these things, an attempt could have been made to obtain a commercial device, which would have added an additional data point in comparison with our device. More importantly, however, it would have given the investigators a way of determining whether the five subjects we were unable to threshold were simply members of the one-third of the population who are phosphene-insensitive, or whether other factors such as head size, skull thickness, or a shortcoming in our device—such as inadequate power or aggressive insulation—was responsible for our inability to evoke.

What is encouraging, however, is that our percentage of non-thresholdable subject aligns with the proportion considered by Meister (2003) to be industry-standard. Five subjects out of 16 is slightly less than a third, 31 percent.

What should also be noted is that the chi-square test used to evaluate our results and the p-value we arrived at considered an even distribution of expected frequencies for thresholding vs. non-thresholding. Knowing as we do now that the distribution is not equal, and a full third of the distribution frequency is likely incorrect, we can have greater confidence in our statistical significance. If we control for this population in the expected frequency distribution, our p-value quickly drops below 0.05 for the main study as well.

Qualitative Results and Discussion

During Post-Threshold Experiments #1 and #2, subjects were asked to qualitatively describe any phenomena they perceived in their visual field. Descriptions of phosphenes from our subject pool are consistent with qualitative descriptions of phosphenes from the clinical literature and historical record. Qualitative descriptors broke down by color, size, shape, and location.

Color and Luminance

"starts purple, then goes to green blobs"

"lightning, purple"

"flash, yellow and purple fading out"

Location

"bright at 8 o'clock"

"scattered light 9 and 12"

"small point"—"white point in center"

Discrete Shape

"[shaped like] Australia"

"[shaped like] Antarctica—whitish color"

Indiscrete Shape

"large, diffuse"

"abstract ripple-white"

Figure 41: Selected qualitative descriptors and metaphors used by subjects during the study.

Although phosphenes can vary widely in size—anything from a single point to a large brightening in a quadrant of the contralateral hemifield—notice should be taken that color descriptors converge on white or “whitish,” purple, yellow, or green, and that often the phosphene will begin as one color, usually a bright purple, and then fade to its complimentary color, a yellow or greenish yellow. “Afterimage” complimentary color is often thought to be completely explained by the depletion of rhodopsin in the photoreceptors sensing the color, but our study seems to indicate that a purely evoked cortical color might also express a similar

behavior; further study is clearly called for. V4 is currently thought to be part of the color processing pathway, and since V2 routes stimulus from V1 regardless of where the stimulus originated, it is likely that the phosphene is being passed through as genuine input and being processed as well as can be managed by V4.

Also absent in the descriptions, and as observed by the investigator, no subject indicates stimulation of the peripheral region. Due to the design constraint imposed by cortical magnification, in which a dense mesh of neurons exists to process foveal input, it was of utmost importance that we stimulate only the slightest amount of the foveal portion of the retinotopic map, lest we swamp the entire hemifield with one immense phosphene. While using the clock face metaphor to describe location, all subjects would indicate that the clock face was small and in front of them. Hand gestures indicating where on the clock face something had been perceived remained close to the mid-line of the body, even when describing a location of 9 or 3 o'clock. At no time did any subject indicate that a phosphene had been spotted in their far peripheral vision. This would indicate that our conservative approach to limiting the area under the focality was successful.

The descriptor "*small point*"—"white point in center" is perhaps the culminating achievement of this dissertation. When setting out to take a medical device used traditionally for therapy or investigation, we explored whether there was even a remote chance of applying its affordances as a display system. I can think of no better description of a pixel than a "*small point*"—"white point in center"

A point small enough to be discrete, bright enough to be perceived, and located within a constrained and intended area shows us that this is indeed possible and future work can progress.

CHAPTER 6: CONTRIBUTIONS AND CONCLUSIONS

The contributions of this work are as follows:

Programmable Synthetic Hallucinations, from vision to case study development of a fully functional, clinically tested, low-cost, wearable, TMS device that acts as a single pixel display with two degrees of freedom. But more than this, the premise of using the mechanics of hallucination as a form of information display is potentially a much larger contribution to the fields of neuroscience and HCI. From the barest shred of an idea gleaned from a science fiction novel up to and including a working instantiation has taken the better part of five years, and we've only just begun to scratch the surface of what is possible with the current technology and what is probable should others enter the field to discover other hallucinatory methods.

Additionally, a basic methodology was developed that allows the evaluation of other hallucinatory technologies. Hallucinatory conditions are numerous, but tend to stem from known deficiencies in either the stimulus or attentional pathways. Deficiencies in both are almost guaranteed to generate hallucinations. To create a hallucination, one must find the cortical area normally responsible for processing the modality of the stimulus and either provide synthetic stimulus in a format the cortex will accept as modulated information or conversely, inhibit the attentional control of the higher cortex and allow noise generated by or introduced into the system to be interpreted as a percept. Such a methodology provides an entry level into designing new hallucinatory technologies, across multiple modalities, and allows incremental improvement in resolution, control, and understanding of the neurobiological fundamentals involved.

This dissertation began with the grand challenge of instantiating the interfaces we've conceptualized or experienced in our favorite science fiction properties for over a century. One oft-repeated effect is the floating, glowing, aerial volume of interactive light, perfectly rendered

in the user's local coordinate space, with parallax in all directions and perspectives rendered properly from any viewer's angle or position. Many different methods have been applied to this long-sought-after effect, each a compromise of scale, depth, resolution, computation, and a host of other constraints. Our reconceptualization of the method, the "how," inverts the normal progression of technological advancement.

The dissertation posited the idea that the extrapolation of existing technologies into higher resolution, faster frame rates, more view angles, user position and gaze tracking, olfactory sprayers, piezoelectric rumble vests, and other "outside-in" solutions, based on a direct lineage of display technologies that came before, was not going to yield the effect we've been searching for. However, since the brain seems capable of rendering higher-resolution imagery than any silicon computer is capable of providing today, or in the foreseeable future, with some yet-to-be-quantified additional sense of reality, exploring how the brain creates this content while it is malfunctioning could lead us to a solution in which we can harness this ability while the brain is functioning normally. How do we make a feature out of a bug?

The research study focused on a physical way to induce the perception of a luminous pixel directly in a participant's visual field, hence their conscious perception, and ultimately their reality. While a single pixel display with two degrees of freedom may seem a far cry from authoring and playing back a full-sensorium hallucination, it represents a grounded, pragmatic, and achievable first step toward harnessing the mechanic of the hallucination process.

The dissertation imparts the story of how a device designed for numerous therapeutic goals can be appropriated as a display technology where none had been used that way before, and then illustrates the science, engineering, design, and artistry needed to create what had previously been science fiction with a clinical medical device. Testing this now very real device in a clinical

environment, gathering data, and calculating reactions and results has added to the body of knowledge needed for others to perhaps take up the mantle and enter the fray of this new and promising field of inquiry.

This thesis may be considered the “Hello, world” of a small portion of the visual realm of possibilities of Programmable Synthetic Hallucinations. What will be the single pixels and “Hello, worlds” for the rest of the sensorium, and who will engineer them?

“Nothing is impossible, but you must have a passion for what you want to do and a plan for where you want to go if you ever hope to get there.”—Buzz Adrin

CHAPTER 7: FUTURE VISION

This section outlines the future of synthetic hallucination research, beginning with near-term plans; applicable next steps that could solidify results and deepen understandings of the current work to date, as well as suggest avenues of inquiry in other regions of the brain, user experiences, and experiments; and finally, forms of energy for achieving hallucinatory effects. More mid-term, we look at possible projects that further iterations may suggest, and uses beyond data display.

The simplest step forward would be in rebuilding the charging circuit so it can fill the capacitor in less than 1ms. This would allow for refresh rates of 10Hz or more. Although Rossi et al. (2009) and Wasserman (1998) limit “safe” duty cycles to 10Hz in regards to possible seizure, many commercial devices are capable of up to 30Hz, although not at full power. While some of the very few seizures attributed to TMS occurred at refresh rates above 10Hz, other mitigating factors were likely more responsible, such as ischemic scars resulting from strokes, or the subject being epileptic and/or on pro-epileptogenic medication (Marg 1991; Rossi et al. 2009).

A new study protocol would need to be submitted to COUHES, with a very defined set of parameters and metrics offered, to get the normal use of the Rossi specification waived. Learning from past studies, a group of phosphene-sensitive subjects would be assembled from a tightly filtered pre-screen that eliminated the 30 percent of subjects who don't seem to see phosphenes immediately. It would also be beneficial to filter this group using a commercial, FDA-approved TMS device such as a Magstim Rapid 2, to ensure that the subjects are not only sensitive but trained to perceive and describe any shaped phenomena that our system might then induce in their field of vision. The ability to drive at 10Hz or more may answer the question of whether two stimulus pulses, one above the calcarine fissure and subsequently one below, would be

perceived as two discreet phenomena separated in time or whether the brain's higher pattern recognition would "tween" the two impulses into a line or other shape.

Further refinement of the charging circuit would require a transformer capable of providing more current, ideally at higher voltage, again to make up for the lack of penetration to which our coils' smaller area limits them. In general, it may benefit the whole system to attempt a slightly larger coil diameter, thus ensuring better penetration, while looking critically at the amount and materials used to insulate the coil. 3D printing or injection molding might make a better fit, with thinner but also stronger coil-pack insulation than the current system's combination of EVA foam and epoxy-set Kevlar.

If either of these improvements could be made to the system, a more rigorous threshold search with tightly controlled voltage settings and frequencies could be explored. Prescreening and comparison with a commercial device would eliminate some of the research questions that were raised by our initial study. A protocol could be designed that allows subjects to self-report any magnetophosphenes administered by an automated Labview application and randomized, double-blind pulse trains of frequencies and voltages to determine whether our system meets or exceeds a commercial device. A recent study by Legros, et al. (2018) indicates that peak flux density may be less important for evoking phosphenes than overall dB/dt and much more frequency-dependent than formerly thought.

Indeed, better results will require a better fit above the visual cortex. A system built on averages leads to a system that fits no one very well, and the addition of the Kevlar lining, while important for safety reasons, also eliminated the flexibility the EVA insulation was originally intended to provide. A possible future system that might provide for a better "impedance match" between the subject and the coil array is one in which the coils could be embedded in a *jamming user*

interface, a system proposed by Hiroshi Ishii's Tangible Media group at the MIT Media Lab (Ou et al. 2014). While the jamming volume is at atmospheric pressure, the coils could be more carefully positioned in relation to scalp or skull landmarks such as the inion. Additionally, being able to hold them precisely parallel to the skull, or made into a slight "v-wing" as found in Medtronic's stimulator coils, could lead to better contact. Once the coil array was ideally positioned and oriented, a vacuum could be pulled on the coil pack "jamsheet" and the coils would lock into a unique configuration, individually matched to the subject's head for the remainder of the session. This ability to match a user's skull topology as well as adjust coil spacing per the individual's occipital lobe size, may result in better rates of phosphene detection and perhaps fewer false positives.

Also arising from our results and supported by others in the same field of research is the interesting finding that time of day seems to have an impact on phosphene perception. A simple but straightforward study could be done—again, ideally with a larger commercial coil—to see if phosphene-sensitive individuals achieve the same level of percepts in the morning versus the afternoon, or beyond. Peter Fried, co-director of the Beth Israel Deaconess Medical Center Core for Noninvasive Brain Stimulation, noted in an email that, "We definitely had more luck at the beginning rather than the end of the day." And indeed, in our study, all but one of our non-thresholdable subjects were admitted during the afternoon. Rather than attempting to determine whether these were a subset of the phosphene-insensitive 30 percent discussed earlier, it would be better to screen a pool of sensitive subjects and test them on multiple occasions at different parts of the day to see if evocation or sensitivity is correlated in any way with time of day, sleep patterns, caffeine ingestion, etc.

While the efficacy of TMS has been proven for therapeutic applications related to depression, PTSD, and other psychological and psychiatric conditions, very little research has been done on

the effects of its long-term use. Several studies in animal and human test subjects indicate that there is lasting therapeutic value and an increase in neuroplasticity over longer periods of use when dosed above 3Hz, but no long-term adverse effects. However, these studies are focused on TMS used in a clinical setting, often following a group of subject who have undergone TMS therapy. As we are the only investigators suggesting the use of TMS or similar technology as a display device, much more effort would need to be put into tracking and determining whether this kind of prolonged use would be safe or pose any serious risks (Gersner et al. 2011; Janicak et al. 2010).

An alternative form factor of the current work is already in the planning stage as part of a collaboration with a Media Lab member company. This automotive manufacturer is interested in the sub-millisecond response time of TMS-evoked phosphenes, and proposes to work with the Object-Based Media group to instantiate a three-coil design, capable of providing a fast and powerful warning indicator built into the headrest of the driver's seat. A headrest form factor alleviates many of the over-constrained aspects of the original device. While the wearable device needed to keep the focality point tightly fixed to the occipital lobe and had a slim window of power and depth penetration in an effort to not overflow the user's foveal region, as an alert system, a large phosphene, quickly delivered, would be ideal. Built into the headrest, the alert system could take advantage of very large coils, thus allowing more freedom for the user to move their head away from the headrest. A simplified three-coil array consisting of a central "positive" coil with two counter-wound output coils would provide a fixed "left" and "right" focality point that could be triggered should a hidden vehicle in the driver's blind spot threaten to turn a lane change into a tragedy. Coils several inches in diameter would be able to reach some portion of the visual cortex even if the driver's head is not in direct contact with the headrest. Results from seminal work on visual prostheses by Giles Brindley and Walpole Lewin suggests

that users may not habituate to induced phosphenes in the same way that they do to warning lights and other external indicators (Brindley and Lewin 1968; Brindley 1971; cited in Sekuler 1974).

While a small, discrete pixel was the goal of the original dissertation, a large warning indicator for automotive safety, meant to save lives, would be a welcome addition to the work. Similarly, warning or navigation aids could be installed within the helmets of first responders such as police and fire personnel (including many members of this researcher's family), who must sometimes navigate smoke-filled or darkened spaces. An evoked phosphene from a curb-side commander with building plans could guide emergency personnel through environments in which their eyes cannot aid them.

Another simple but necessary forward step would be to determine what charge voltages above 2kV would afford. Some commercial TMS devices are beginning to look at 2.2kV or more. While coil-design factors such as number of turns, inductance, and capacitance ensure that the pulse shape and duration remains below the time constant of the neuron, adding additional voltage would result in more current and hence a stronger magnetic field without overly lengthening the pulse duration. Phosphene size is determined by the area and number of neurons being stimulated below the focality but phosphene density or "opaqueness" is linearly related to voltage. The more voltage pumped through the coil, the brighter and more prominent the phosphene appears. Strict limitations would of course need to be determined based on the strength of the E-field induced by the B-field and how much heat would be produced for this increased amount of current from the higher voltage.

Results from our initial Experiments #1 also merit additional investigation by future researchers. In the experiment with the eyes closed, half as many false positives were reported as true

positives. While this seems intuitively correct and desirable, the number is slightly above what pure chance would indicate—suggesting, perhaps, that some stray effect may be involved. While a reported phosphene in a non-contralateral location was considered a false positive in our study, the fact that a suprathreshold discharge was reported in an incorrect location is of interest.

One possible explanation is that stimulation was taking place in extrastriate areas of V3, V4, V5, or even the parietal lobe. All of these areas backfeed into V1 and V2 and can be perceived in a retinocentric frame-of-reference but not inverted into the proper vertical hemifield (Fried 2019). This would explain phosphenes that were reported as horizontally contralateral but not vertically, of which we had a number. Parietal phosphenes also appear as less vivid than and not as sharply demarcated as occipital ones; thus, it may be possible to study the reported strength of the incorrectly reported phosphene to determine whether our coil array, when fitted to a subject with a smaller head and smaller visual cortex, may have been off the striate area and stimulating extrastriate phosphenes.

We also had a small number of false positives that were ipsilateral. Elwin Marg and David Rudlak note that “paradoxical ipsilateral phosphenes may occur when stimulating substantially above threshold due to nonlocalized current spread” (1994). Given the power level of our device, it is possible that several of our false positives may have been a result of this condition.

Moving further afield, and into the broader sense of the wider setting of Programmable Synthetic Hallucinations, a coil array extending over the full area of a helmet could be considered. While coil spacing is somewhat fixed and each individual coil’s area determined by the necessity of ensuring an adequate penetration depth, other areas beyond the visual cortex could be examined and explored. For example, what would be the result of stimulating V4 while simultaneously evoking a phosphene in V1? Since V4 is commonly thought to process color, we might expect

the color of the phosphene to shift or alter in some way. Or, moving higher up the attentional circuits into medial or temporal areas where there is a less direct 1:1 mapping of stimulus to response—into an area of the fusiform gyrus, like the face-finding area, or other areas that become hyperactive in conditions like Charles Bonnet Syndrome—would an evoked phosphene begin to take on the features that particular area is responsible for? Would stimulating the area without phosphene evocation drive it into a minor hyperactive state so that normal input from the retina begins to become recognized as that area’s target? Can we stimulate or modulate apophenia?

Moving up to the prefrontal cortex, the area to which TMS is commonly targeted as a treatment for depression, can we find power levels or frequencies that would excite or inhibit the 40Hz gamma oscillations that are responsible for the integration of time, proprioception, and other inputs that become the sense of self? One promising mechanism that may explain the emergence of hallucinations when the system operates incorrectly is based on sustained assemblies of coherent gamma oscillations in thalamocortical circuits (Behrendt 2006). Gamma oscillation at 40Hz seems to be related to waking consciousness, dream imagery, and hallucinations. In a normally functioning brain, 40Hz gamma oscillations appear during attentional focus, memory recall, and properly functioning perception.

Sensory input seems not to be an equal player supplying information in a “top-down” / “bottom-up” scenario, but acts rather in an inhibitory role, constraining the top-down attentional mechanism and establishing gamma oscillations. Disruption of this sensory constraint—whether by deprivation, degeneration, or drug action—may disturb the function of the reticular thalamic nucleus. During arousal or focused attention, cells in specific thalamic nuclei may then be activated by attentional mechanisms alone, and induced by nonspecific thalamic nuclei to

participate in coherent assemblies of thalamocortical gamma activity, thus creating an hallucinatory perception (ibid).

To simplify, without sensory input and its inhibitory constraint, 40Hz gamma oscillation creates a percept out of nonspecific thalamocortical noise. This is also thought to be the mechanism underlying dream activity during sleep, which of course is defined by a lack of input stimulus. So in essence, hallucinations can be thought of partially as dreaming while awake, at least from a neuromechanical standpoint. Can we modulate the magnetic pulse shape, duration, and frequency to match the patterns we see in the prefrontal cortex of a subject in an fMRI who is experiencing hallucinations or an altered state of consciousness? There is research that a 40Hz stimulating signal timed with the entry into REM during sleep can induce a state of lucid dreaming. TMS, transcranial ultrasound, or possibly time interference stimulation could be a valuable tool for exploring this phenomenon.

Ultimately, in the shorter term, future work would have to focus on creating a user experience very similar to today's HUD or AR applications. The information carried by the system is designed to be overlaid on the current visual field, rather than replacing the visual field as screen-based VR solutions do. Minimally, user data like date, clock, temperature, and appointments could be displayed. More complex navigational aids could also be added. Safety data for construction or plant operations could be displayed without requiring safety goggles to perform double duty as displays. Targeting reticles as well as flight information could be displayed to military or civilian pilots. Drivers would be able to see important state information without removing their eyes from the road. Combined with an IR camera, night vision or edge detection could be overlaid within a user's field of view at night in real time. Eventually, we hope that a gaming platform could be also be developed, allowing augmented play while simultaneously maintaining important human face-to-face interaction.

Ultimately, it is unlikely that magnetic stimulation will ever be focusable to a useful pixel size. However, a combination of magnetic and perhaps ultrasound or one of the other forms of energetic stimulation previously mentioned, could be a fruitful avenue for future enquiry.

REFERENCES

- Abovitz, Rony, Brian T. Schowengerdt, and Matthew D. Watson. 2015. Planar waveguide apparatus with diffraction element(s) and system employing same. United States US20150016777A1, filed July 14, 2014, and issued January 15, 2015. <https://patents.google.com/patent/US20150016777/en>.
- Alba, Michael. 2016. "Playing Video Games with Direct Brain Stimulation." *Engineering.Com* (blog). December 12, 2016. <https://www.engineering.com/DesignerEdge/DesignerEdgeArticles/ArticleID/13896/Playing-Video-Games-with-Direct-Brain-Stimulation.aspx>.
- Barker, Anthony T., Ian L. Freestone, John A. Jarrett, and Reza Jalinous. 1990. "Magnetic Stimulation of the Human Nervous System: An Introduction and Basic Principles." In *Magnetic Stimulation in Clinical Neurophysiology*, edited by Sudhansu Chokroverty, 55–72. Butterworths.
- Beck, Stephen C. 1984. "The Phosphotron." *SEND*, Spring 1984. [http://www.vasulka.org/archive/4-30b/Seno\(9007\).pdf](http://www.vasulka.org/archive/4-30b/Seno(9007).pdf).
- . 1987. Apparatus and method for generating phosphenes. United States US4664117A, filed October 9, 1984, and issued May 12, 1987. <https://patents.google.com/patent/US4664117A/en?inventor=Stephen+Beck&oq=Stephen+Beck>.
- . n.d. "Phosphotron." Steve Beck. Accessed February 17, 2019. <http://www.stevebeck.tv/phosphotron.htm>.
- Behrendt, Ralf-Peter. 2006. "Dysregulation of Thalamic Sensory 'Transmission' in Schizophrenia: Neurochemical Vulnerability to Hallucinations." *Journal of Psychopharmacology (Oxford, England)* 20 (3): 356–72. <https://doi.org/10.1177/0269881105057696>.
- Bikson, Marom, Abhishek Datta, and Maged Elwassif. 2009. "Establishing Safety Limits for Transcranial Direct Current Stimulation." *Clinical Neurophysiology: Official Journal of the International Federation of Clinical Neurophysiology* 120 (6): 1033–34. <https://doi.org/10.1016/j.clinph.2009.03.018>.
- Bonmassar, Giorgio, John Gale, and Wim Vanduffel. 2014. "Optimizing Microscopic Magnetic Fields for Neuronal Stimulation." *International Journal of Bioelectromagnetism* 16 (1): 1–31.
- Brindley, Giles S. 1971. "Report to the Conference on Visual Prosthesis." *Visual Prosthesis, The Interdisciplinary Dialogue*, 41–48.
- Brindley, Giles S., and Walpole S. Lewin. 1968. "The Sensations Produced by Electrical Stimulation of the Visual Cortex." *The Journal of Physiology* 196 (2): 479–93. <https://www.ncbi.nlm.nih.gov/pmc/articles/PMC1351724/>.
- Brindley, Giles S., and David N. Rushton. 1974. "Implanted Stimulators of the Visual Cortex as Visual Prosthetic Devices." *Transactions of the American Academy of Ophthalmology and Otolaryngology* 78 (5): O741–45.
- Cohen, David, and B. Neil Cuffin. 1991. "Developing a More Focal Magnetic Stimulator. Part I: Some Basic Principles." *Journal of Clinical Neurophysiology: Official Publication of the American Electroencephalographic Society* 8 (1): 102–11.

- Cohen, Leonardo G., and Mark Hallett. 1988. "Non-Invasive Electrical Stimulation of the Brain Does Not Cause Short-Term Changes in the Electroencephalogram." In *Non-Invasive Stimulation of the Brain and Spinal Cord: Fundamentals and Clinical Application*. (Proceedings of a Workshop Held in Sorrento, Italy, May 24–29, 1987), edited by Paolo M. Rossini and Charles D. Marsden, 159–61. New York: Alan R. Liss, Inc.
- Cooray, Vernon, Gerald Cooray, and Joseph Dwyer. 2011. "On the Possibility of Phosphenes Being Generated by the Energetic Radiation from Lightning Flashes and Thunderstorms." *Physics Letters, Section A: General, Atomic and Solid State Physics* 375 (42): 3704–9. <https://doi.org/10.1016/j.physleta.2011.08.055>.
- Davis, Nick J., and Martijn G. van Koningsbruggen. 2013. "'Non-Invasive' Brain Stimulation Is Not Non-Invasive." *Frontiers in Systems Neuroscience* 7 (December). <https://doi.org/10.3389/fnsys.2013.00076>.
- Deng, Zhi-De, Sarah H. Lisanby, and Angel V. Peterchev. 2013. "Electric Field Depth–Focality Tradeoff in Transcranial Magnetic Stimulation: Simulation Comparison of 50 Coil Designs." *Brain Stimulation* 6 (1): 1–13. <https://doi.org/10.1016/j.brs.2012.02.005>.
- Dick, Philip K. 1968. *Do Androids Dream of Electric Sheep?* New York: Doubleday.
- Dobelle, William H., Michael G. Mladejovsky, and J. P. Girvin. 1974. "Artificial Vision for the Blind: Electrical Stimulation of Visual Cortex Offers Hope for a Functional Prosthesis." *Science* 183 (4123): 440–44. <https://doi.org/10.1126/science.183.4123.440>.
- Eisenberg, Anne. 2010. "Holograms Moving From Science Fiction to Reality." *The New York Times*, December 4, 2010, sec. Business Day. <https://www.nytimes.com/2010/12/05/business/05novel.html>.
- Engel, Stephen A., David E. Rumelhart, Brian A. Wandell, Adrian T. Lee, Gary H. Glover, Eduardo-Jose Chichilnisky, and Michael N. Shadlen. 1994. "fMRI of Human Visual Cortex." *Nature* 369 (6481): 525–525. <https://doi.org/10.1038/369525a0>.
- Evans, Anwen. 2007. "A Review of the Safety of Transcranial Magnetic Stimulation." Carmarthenshire, UK: The Magstim Company Limited.
- Fried, Peter J. Letter to Daniel Novy. 2019. "Re: Contralateral Phosphenes but Not in the Vertical?," January 27, 2019.
- Gabor, Dennis. 1949. "Microscopy by Reconstructed Wave-Fronts." *Proceedings of the Royal Society of London. Series A. Mathematical and Physical Sciences* 197 (1051): 454–87. <https://doi.org/10.1098/rspa.1949.0075>.
- . 1971. "Holography, 1948–1971." *Nobel Lectures, Physics*.
- George, Mark S., Daryl E. Bohning, Jeffrey Lorberbaum, Ziad Nahas, Berry S. Anderson, Jeffrey J. Borckardt, Chris Molnar, Samet Kose, Raffaella Ricci, and Kamal Rastogi. 2007. "Overview of Transcranial Magnetic Stimulation: History, Mechanisms, Physics, and Safety." In *Transcranial Magnetic Stimulation (TMS) in Clinical Psychiatry*, edited by Mark S. George and Robert H. Belmaker, 1–50. Washington, DC: American Psychiatric Association Publishing. https://www.appi.org/transcranial_magnetic_stimulation_in_clinical_psychiatry.
- Gersner, R., E. Kravetz, J. Feil, G. Pell, and A. Zangen. 2011. "Long-Term Effects of Repetitive Transcranial Magnetic Stimulation on Markers for Neuroplasticity: Differential Outcomes in Anesthetized and Awake Animals." *Journal of Neuroscience* 31 (20): 7521–26. <https://doi.org/10.1523/JNEUROSCI.6751-10.2011>.
- Grau, Carles, Romuald Ginhoux, Alejandro Riera, Thanh Lam Nguyen, Hubert Chauvat, Michel Berg, Julià L. Amengual, Alvaro Pascual-Leone, and Giulio Ruffini. 2014. "Conscious Brain-to-Brain Communication in Humans Using Non-Invasive Technologies." *PLOS ONE* 9 (8): e105225. <https://doi.org/10.1371/journal.pone.0105225>.

- Grimaldi, G., G. P. Argyropoulos, A. Boehringer, P. Celnik, M. J. Edwards, R. Ferrucci, J. M. Galea, et al. 2014. "Non-Invasive Cerebellar Stimulation—a Consensus Paper." *The Cerebellum* 13 (1): 121–38. <https://doi.org/10.1007/s12311-013-0514-7>.
- Grossman, Nir, David Bono, and Edward Boyden. 2019. Methods and apparatus for stimulation of biological tissue. United States US10173061B2, filed October 8, 2015, and issued January 8, 2019. <https://patents.google.com/patent/US10173061B2/en>.
- Grüsser, Otto-Joachim, and Michael Hagner. 1990. "On the History of Deformation Phosphenes and the Idea of Internal Light Generated in the Eye for the Purpose of Vision." In *History of Ophthalmology: Sub Auspiciis Academiae Ophthalmologicae Internationalis*, edited by H. E. Henkes and Cl. Zrenner, 57–85. History of Ophthalmology. Dordrecht: Springer Netherlands. https://doi.org/10.1007/978-94-009-0641-9_7.
- Hamilton, Edward. 1928. *Crashing Suns*. Chicago: Weird Tales.
- "Holodeck." 2016. NYU-X. 2016. <http://www.nyu-x.org/holodeck.html>.
- Horgan, John. 2005. "The Forgotten Era of Brain Chips." *Scientific American* 293 (4): 66–73. <https://doi.org/10.1038/scientificamerican1005-66>.
- Iron Man* 3. 2013. Marvel Studios. <http://www.imdb.com/title/tt1300854/>.
- Janicak, Philip G., Ziad Nahas, Sarah H. Lisanby, H. Brent Solvason, Shirlene M. Sampson, William M. McDonald, Lauren B. Marangell, et al. 2010. "Durability of Clinical Benefit with Transcranial Magnetic Stimulation (TMS) in the Treatment of Pharmacoresistant Major Depression: Assessment of Relapse during a 6-Month, Multisite, Open-Label Study." *Brain Stimulation* 3 (4): 187–99. <https://doi.org/10.1016/j.brs.2010.07.003>.
- Jiang, Linxing, Andrea Stocco, Darby M. Losey, Justin A. Abernethy, Chantel S. Prat, and Rajesh P. N. Rao. 2018. "BrainNet: A Multi-Person Brain-to-Brain Interface for Direct Collaboration Between Brains." *ArXiv:1809.08632 [Cs, q-Bio]*, September. <http://arxiv.org/abs/1809.08632>.
- Kandler, Rosalind. 1990. "Safety of Transcranial Magnetic Stimulation." *The Lancet* 335 (8687): 469–70. [https://doi.org/10.1016/0140-6736\(90\)90696-3](https://doi.org/10.1016/0140-6736(90)90696-3).
- Knoll, M., O. Höfer, Standish D. Lawder, and Ursula M. Lawder. 2009. "Die Reproduzierbarkeit von Elektrisch Angeregten Lichterscheinungen (Phosphenen) Bei Zwei Versuchspersonen Innerhalb von 6 Monaten." *Biomedizinische Technik/Biomedical Engineering* 7 (4): 235–242. <https://doi.org/10.1515/bmte.1962.7.4.235>.
- Koponen, Lari. 2013. "Large Thin Overlapping Coils, a Novel Approach for Multichannel Transcranial Magnetic Stimulation." Aalto University. <https://aaltodoc.aalto.fi:443/handle/123456789/28098>.
- Legros, Alexandre, Julien Modolo, Michael Corbacio, Daniel Goulet, Michel Plante, Martine Souques, Francois Deschamps, Genevieve Ostiguy, Jacques Lambrozo, and Alex Thomas. 2018. "Magnetophosphenes in Humans Exposed to ELF MF up to 50 MT, a Threshold Study." *BioRxiv*, October, 439968. <https://doi.org/10.1101/439968>.
- Lewis, Philip M., and Jeffrey V. Rosenfeld. 2016. "Electrical Stimulation of the Brain and the Development of Cortical Visual Prostheses: An Historical Perspective." *Brain Research* 1630 (January): 208–24. <https://doi.org/10.1016/j.brainres.2015.08.038>.
- Losey, Darby M., Andrea Stocco, Justin A. Abernethy, and Rajesh P. N. Rao. 2016. "Navigating a 2D Virtual World Using Direct Brain Stimulation." *Frontiers in Robotics and AI* 3. <https://doi.org/10.3389/frobt.2016.00072>.
- Marg, Elwin. 1991. "Magnetostimulation of Vision: Direct Noninvasive Stimulation of the Retina and the Visual Brain." *Optometry and Vision Science : Official Publication of the American Academy of Optometry* 68 (6): 427–40. <http://europepmc.org/abstract/med/1891194>.

- Marg, Elwin, and David Rudiak. 1994. "Phosphenes Induced by Magnetic Stimulation Over the Occipital Brain: Description and Probable Site of Stimulation." *Optometry and Vision Science* 71 (5): 301.
https://journals.lww.com/optvissci/Abstract/1994/05000/Phosphenes_Induced_by_Magnetic_Stimulation_Over.1.aspx.
- Meister, Ingo G., Juergen Weidemann, Nina Dambeck, Henrik Foltys, Roland Sparing, Timo Krings, Armin Thron, and Babak Boroojerdi. 2003. "Chapter 31: Neural Correlates of Phosphene Perception." In *Supplements to Clinical Neurophysiology*, edited by Walter Paulus, Frithjof Tergau, Michael A. Nitsche, John C. Rothwell, Ulf Ziemann, and Mark Hallett, 56:305–11. Transcranial Magnetic Stimulation and Transcranial Direct Current Stimulation. Elsevier. [https://doi.org/10.1016/S1567-424X\(09\)70234-X](https://doi.org/10.1016/S1567-424X(09)70234-X).
- Mould, Stephen. 2001. Coil assemblies for magnetic stimulators. United States US6179770B1, filed April 16, 1999, and issued January 30, 2001.
<https://patents.google.com/patent/US6179770B1/en>.
- Nirenberg, Sheila, and Chethan Pandarinath. 2012. "Retinal Prosthetic Strategy with the Capacity to Restore Normal Vision." *Proceedings of the National Academy of Sciences* 109 (37): 15012–17. <https://doi.org/10.1073/pnas.1207035109>.
- Novy, Daniel, and V. Michael Bove. 2015. "Aerial Light-Field Display." MIT Media Lab. 2015.
<https://www.media.mit.edu/projects/aerial-light-field-display/overview/>.
- Oatley, Keith. 2016. "Fiction: Simulation of Social Worlds." *Trends in Cognitive Sciences* 20 (8): 618–28. <https://doi.org/10.1016/j.tics.2016.06.002>.
- Ou, Jifei, Lining Yao, Daniel Tauber, Jürgen Steimle, Ryuma Niiyama, and Hiroshi Ishii. 2014. "JamSheets: Thin Interfaces with Tunable Stiffness Enabled by Layer Jamming." In *Tangible and Embedded Interaction*. <https://doi.org/10.1145/2540930.2540971>.
- Peer, Joseph, and Alexander Kendl. 2010. "Transcranial Stimulability of Phosphenes by Long Lightning Electromagnetic Pulses." *Physics Letters A* 374 (29): 2932–35.
<https://doi.org/10.1016/j.physleta.2010.05.023>.
- Penfield, Wilder. 1958. "Some Mechanisms of Consciousness Discovered During Electrical Stimulation of the Brain." *Proceedings of the National Academy of Sciences of the United States of America* 44 (2): 51–66.
<https://www.ncbi.nlm.nih.gov/pmc/articles/PMC335365/>.
- Rosenboom, David, ed. 1975. *Biofeedback and the Arts: Results of Early Experiments*. Vancouver: Aesthetic Research Centre of Canada Publications.
- Rossi, Simone, Mark Hallett, Paolo M. Rossini, and Alvaro Pascual-Leone. 2009. "Safety, Ethical Considerations, and Application Guidelines for the Use of Transcranial Magnetic Stimulation in Clinical Practice and Research." *Clinical Neurophysiology* 120 (12): 2008–39. <https://doi.org/10.1016/j.clinph.2009.08.016>.
- Roth, Bradley, Leonardo G. Cohen, and Mark Hallett. 1991. "The Electric Field Induced during Magnetic Stimulation." *Electroencephalography and Clinical Neurophysiology. Supplement* 43: 268–78.
- Sekuler, R. 1974. "Spatial Vision." *Annual Review of Psychology* 25 (1): 195–232.
<https://doi.org/10.1146/annurev.ps.25.020174.001211>.
- Shankar, Hariharan, and Paul S. Pagel. 2011. "Potential Adverse Ultrasound-Related Biological Effects: A Critical Review." *Anesthesiology* 115 (5): 1109–24.
<https://doi.org/10.1097/ALN.0b013e31822fd1f1>.
- Smith, E. E. "Doc." 1934. *Triplanetary: A Tale of Cosmic Adventure*. Amazing Stories.
 "Strength-Duration Curve." n.d. The McGill Physiology Virtual Lab. Accessed February 18, 2019. <http://www.medicine.mcgill.ca/physio/vlab/CAP/S-D.htm>.

- Talebinejad, Mehran, Sam Musallam, and Andrew E. Marble. 2011. "A Transcranial Magnetic Stimulation Coil Using Rectangular Braided Litz Wire." In *2011 IEEE International Symposium on Medical Measurements and Applications*, 280–83. <https://doi.org/10.1109/MeMeA.2011.5966664>.
- Tassinari, Carlo Alberto, Massimo Cincotta, Gaetano Zaccara, and Roberto Michelucci. 2003. "Transcranial Magnetic Stimulation and Epilepsy." *Clinical Neurophysiology: Official Journal of the International Federation of Clinical Neurophysiology* 114 (5): 777–98.
- Thielscher, Axel, and Thomas Kammer. 2004. "Electric Field Properties of Two Commercial Figure-8 Coils in TMS: Calculation of Focality and Efficiency." *Clinical Neurophysiology* 115 (7): 1697–1708. <https://doi.org/10.1016/j.clinph.2004.02.019>.
- Wagner, Timothy, Antoni Valero-Cabre, and Alvaro Pascual-Leone. 2007. "Noninvasive Human Brain Stimulation." *Annual Review of Biomedical Engineering* 9 (1): 527–65. <https://doi.org/10.1146/annurev.bioeng.9.061206.133100>.
- Wassermann, Eric M. 1998. "Risk and Safety of Repetitive Transcranial Magnetic Stimulation: Report and Suggested Guidelines from the International Workshop on the Safety of Repetitive Transcranial Magnetic Stimulation, June 5-7, 1996." *Electroencephalography and Clinical Neurophysiology* 108 (1): 1–16.
- Wassermann, Eric M., and Trelawny Zimmermann. 2012. "Transcranial Magnetic Brain Stimulation: Therapeutic Promises and Scientific Gaps." *Pharmacology & Therapeutics* 133 (1): 98–107. <https://doi.org/10.1016/j.pharmthera.2011.09.003>.
- Wysocki, Edward. 2011. "John W. Campbell, Jr., E.E. 'Doc' Smith, and the Combat Information Center." *Science Fiction Studies* 38 (3): 558–62. <https://doi.org/10.5621/sciefictstud.38.3.0558>.

AUTHOR BIOGRAPHY

Dan Novy (also known as NovySan) is a PhD student at the MIT Media Lab, where he works to decrease the alienation fostered by traditional passive media consumption; increase social interaction through transparent, interconnected and fluid media; and create enriched, active, and inspired immediate experiences. He is an Emmy- and Visual Effects Society Award-winning VFX technical supervisor, transmedia experience designer, and artist. At the University of Illinois at Urbana-Champaign, he received a BFA in theatre and an MA in theatre history, with a double emphasis in the technical history of the theatre and shamanic ritual performance in pre- agrarian societies. He is the former Chair of the Visual Effects Society's Technology Committee and co-instructor of the Media Lab's “Science Fiction-Inspired Prototyping” and “Indistinguishable from Magic” classes. He received an MS in Media Arts and Sciences from the Massachusetts Institute of Technology in 2013.

LIST OF FIGURES

<i>Figure 1: The Princess Leia Lie</i> _____	16
<i>Figure 2: A fictional user interface (FUI) from Iron Man 3 (Marvel Studios 2013).</i> _____	18
<i>Figure 3: Visual processing areas of the occipital lobe.</i> _____	26
<i>Figure 4: Retinotopic mapping of the visual field.</i> _____	27
<i>Figure 5: Retinal electrophosphene induction, 1755</i> _____	29
<i>Figure 6: S. P. Thompson attempting to evoke a magnetophosphene in 1910.</i> _____	31
<i>Figure 7: Schematic of analog Phosphotron from US Patent filing (Beck 1987), with illustrations of its use and inspirations. Image from Stephen Beck's website (http://www.stevebeck.tv/phosphotron.htm).</i> _____	33
<i>Figure 8: Typical maze to be solved unseen based only on phosphene perception (Losey et al. 2016).</i> _____	36
<i>Figure 9: Basic TMS block diagram</i> _____	45
<i>Figure 10: Pinout of commercial Magstim Rapid 2 connector.</i> _____	48
<i>Figure 11: Error message on faulty Magstim Rapid 2.</i> _____	49
<i>Figure 12: eBay listing for an untested, yet allegedly operational, Magstim Rapid 2.</i> _____	50
<i>Figure 13: Interior of Ono-Sendai Cyberspace 1.</i> _____	54
<i>Figure 14: Closeup of the high-voltage power supply and bridge rectifier.</i> _____	56
<i>Figure 15: Schematic of Ono-Sendai Cyberspace 1.</i> _____	59
<i>Figure 16: Original configuration of Magstim Rapid 2</i> _____	60
<i>Figure 17: Front view of Ono-Sendai Cyberspace 1</i> _____	61
<i>Figure 18: User interface of the Magstim Rapid 2.</i> _____	62
<i>Figure 19: Patent illustration of Magstim 70mm "butterfly" coil (Mould 2001).</i> _____	65
<i>Figure 20: X-ray of commercial Magstim and Medtronic figure-of-8 coils (Thielscher and Kammer 2004).</i> _____	65
<i>Figure 21: The electric field induced in a homogeneous conductor, calculated in a plane parallel to the coil plane (Thielscher and Kammer 2004).</i> _____	66
<i>Figure 22: Talebinejad results (2011).</i> _____	69
<i>Figure 23: FEMM 30mmButterflyCoil_10kA_6.6kHz</i> _____	70
<i>Figure 24: FEMM 30mmOverlappedButterflyCoil_10kA_6.6kHz</i> _____	70
<i>Figure 25: Initial 30mm Litz wire test coils.</i> _____	71
<i>Figure 26: Measuring height of magnet propelled by 30mm Litz wire coils.</i> _____	72

<i>Figure 27: Ferrofluid visualization of butterfly focality filmed at 120fps (8.33ms).</i>	73
<i>Figure 28: First of the 50mm coils in butterfly configuration.</i>	74
<i>Figure 29: Inductor simulation by Barry Hansen, available at https://coilgun.info/mark2/inductorsim.htm.</i>	75
<i>Figure 30: Determining inductance for a known capacitance and time constant, using a simulator developed by Barry Hansen, available at https://coilgun.info/mark2/timesim.htm.</i>	76
<i>Figure 31: SPICE simulation of voltage and current discharge curve. Screenshot from https://partstim.com.</i>	77
<i>Figure 32: Biphasic/Damped polyphasic output waveform from search coil.</i>	78
<i>Figure 33: LEGO Mindstorms-based coil-winding jig.</i>	79
<i>Figure 34: Milling and thermal epoxy potting of coils.</i>	80
<i>Figure 35: H bridge array in vehicle headrest orientation.</i>	80
<i>Figure 36: Wearable array with isolation hood for dark adaptation.</i>	81
<i>Figure 37: Ribboned #14 AWG and re-potting in epoxy.</i>	82
<i>Figure 38: Shielded control box with arcade style buttons.</i>	83
<i>Figure 39: REDCap—Research Electronic Data Capture system.</i>	94
<i>Figure 40: Device in use during clinical trials.</i>	98
<i>Figure 41: Selected qualitative descriptors and metaphors used by subjects during the study.</i>	103

APPENDIX

Seeking Study Participants for research on Noninvasive Brain Stimulation technique

We investigate a noninvasive brain stimulation technique that creates phenomena within the visual field with an overall aim to create a novel display device.

We are looking for volunteers to take part in the study.

Participants must be/have

- 18—55 years of age,
- No history of neurological disorders or a current history of a psychiatric illness or any unstable medical conditions.
- No cardiac pacemaker or intracranial metal implantation.
- Other conditions will apply

Participants will not be compensated for their participation.

If you are interested to learn more, please contact

Dan Novy, novysan@media.mit.edu or fill in the following form:

[Transcranial Magnetic Evocation of Magnetophosphenes Study](#)

Screening

Thank You for your interest in the TMS study.

Please complete the survey below to determine if you are eligible to participate.

If you meet the requirements to enter the study we will be in contact to schedule an appointment.

Today's Date _____

Please provide your email so we may contact you to schedule a research screening visit. _____

Are you between the age of 18 and 55? Yes No

Any chance you may be pregnant? Yes No N/A Male

Do you have any of the following? Implanted devices: - cardiac pacemakers - medical pumps Yes No

Do you have any metal within your head, except for your mouth? Yes No

Have you experienced any of the following? - Severe head trauma - History or severe headaches - History of neurological disorders or brain trauma (e.g. stroke) - History of seizures or syncope - Family history of epilepsy - Increased intracranial pressure - Past spinal surgery - Spinal ventricular derivations Yes No

Are you able to refrain from the following at least one week before the visit? - Narcotics - Stimulants (with the exception of caffeine) - Cocaine - LSD - Marijuana Yes No

Do you currently have any active infections or a chronic disease? Yes No

Availability

Thank you for your interest in the "Transcranial Magnetic Evocation of Magnetophosphenes Study."

Please fill in your general weekday availability below for the next week.

Thank you!

Please indicate your availability for the next 3 weeks in January. Please indicate all that apply.

	8am	9am	10am	11am	12pm	1pm	2pm	3pm	4pm	5pm
10) Monday	<input type="checkbox"/>	<input type="checkbox"/>	<input type="checkbox"/>	<input type="checkbox"/>	<input type="checkbox"/>	<input type="checkbox"/>	<input type="checkbox"/>	<input type="checkbox"/>	<input type="checkbox"/>	<input type="checkbox"/>
11) Tuesday	<input type="checkbox"/>	<input type="checkbox"/>	<input type="checkbox"/>	<input type="checkbox"/>	<input type="checkbox"/>	<input type="checkbox"/>	<input type="checkbox"/>	<input type="checkbox"/>	<input type="checkbox"/>	<input type="checkbox"/>
12) Wednesday	<input type="checkbox"/>	<input type="checkbox"/>	<input type="checkbox"/>	<input type="checkbox"/>	<input type="checkbox"/>	<input type="checkbox"/>	<input type="checkbox"/>	<input type="checkbox"/>	<input type="checkbox"/>	<input type="checkbox"/>
13) Thursday	<input type="checkbox"/>	<input type="checkbox"/>	<input type="checkbox"/>	<input type="checkbox"/>	<input type="checkbox"/>	<input type="checkbox"/>	<input type="checkbox"/>	<input type="checkbox"/>	<input type="checkbox"/>	<input type="checkbox"/>
14) Friday	<input type="checkbox"/>	<input type="checkbox"/>	<input type="checkbox"/>	<input type="checkbox"/>	<input type="checkbox"/>	<input type="checkbox"/>	<input type="checkbox"/>	<input type="checkbox"/>	<input type="checkbox"/>	<input type="checkbox"/>
15) Propose other availability.	(include day and time)									

CRC Study Registration

Please complete the survey below.

Thank you!

Contact Information

- 16) First Name _____
- 17) Last Name _____
- 18) Street, City, State, ZIP _____
- 19) Phone number _____
(Include Area Code)
- 20) E-mail _____
- 21) Date of birth _____
- 22) Age (years) _____
- 23) Ethnicity Hispanic or Latino
 NOT Hispanic or Latino
 Unknown / Not Reported
- 24) Race American Indian/Alaska Native
 Asian
 Native Hawaiian or Other Pacific Islander
 Black or African American
 White
 More Than One Race
 Unknown / Not Reported
- 25) Gender Female
 Male
 Transgender Female
 Transgender male
 Other
 Do not wish to answer
- 26) Other gender _____
- 27) Height (cm) _____
- 28) Weight (kg) _____
- 29) BMI _____
- 30) Ht feet _____
- 31) Ht inches _____
- 32) Weight Pounds _____
- 33) BMI _____

General Comments

34) Comments

Please find the consent form attached for you review.

We will answer all of your questions during the visit and if you agree to participate we'll sign the consent form at the enrollment visit.

[Attachment: "NOVY_Consent_for RedCap_No Last page.pdf"]

Consent

Date Consented

Informed Consent Process Performed By

-
- Catherine Ricciardi DNP, ANP-BC
 - Tatiana Urman, MSN, RN
 - Dan Novy PhD (c)

Upload Signed Consent

Upload other

Enrollment criteria

Begin Screen

Inclusion/Exclusion Criteria

	Yes	No
Subject between 18-55 years of age	<input type="checkbox"/>	<input type="checkbox"/>
Metal anywhere in the head (excluding mouth)	<input type="checkbox"/>	<input type="checkbox"/>
Severe head trauma	<input type="checkbox"/>	<input type="checkbox"/>
Hx of severe headaches	<input type="checkbox"/>	<input type="checkbox"/>
Hx neurological disorders or brain trauma	<input type="checkbox"/>	<input type="checkbox"/>
Increase intracranial pressure	<input type="checkbox"/>	<input type="checkbox"/>
Past spinal surgery	<input type="checkbox"/>	<input type="checkbox"/>
Spinal Ventricular derivations	<input type="checkbox"/>	<input type="checkbox"/>
Hx of seizures or syncope	<input type="checkbox"/>	<input type="checkbox"/>
Hx of epilepsy	<input type="checkbox"/>	<input type="checkbox"/>
Hearing problems or chronic tinnitus	<input type="checkbox"/>	<input type="checkbox"/>
Implanted medication pumps or infusers	<input type="checkbox"/>	<input type="checkbox"/>
Serious heart disease	<input type="checkbox"/>	<input type="checkbox"/>
Cardiac pacemaker or other electrodes inside the heart	<input type="checkbox"/>	<input type="checkbox"/>
Known or suspected pregnancy	<input type="checkbox"/>	<input type="checkbox"/>
Sleep deprivation (less than 4 hrs night before)	<input type="checkbox"/>	<input type="checkbox"/>
Taking brain stimulants (except for caffeine)	<input type="checkbox"/>	<input type="checkbox"/>

Was HCG (Pregnancy) Test Negative? Yes
 No
 Male

HCG test image (if applicable)

Neurological and Medical History

Do you have a current or past history of a neurological disorder or a psychiatric illness? Yes
 No

If Yes please provide details and circumstances _____

Do you suffer from frequent or severe headaches? Yes
 No

Do you have a history of migraine headaches? Yes
 No

If yes, please provide details including approximate date of last migraine, how often and precipitating factors _____

Have you been diagnosed with epilepsy? Yes
 No

Have you ever had a seizure? Yes
 No

Approximate date of last seizure _____

What precipitated seizure? _____

Does anyone in your immediate family experience seizures or have been diagnosed with epilepsy? Yes
 No

What is the relationship of family member with epilepsy/seizure disorder? _____

Have you ever experienced a loss of consciousness, concussion or other brain related injury? Yes
 No

If yes please provide details _____

Have you ever had a stroke? Yes
 No

Approximated date of stroke _____

Do you have any other medical condition? Yes
 No

If Yes please provide details of your medical treatment and current treatment _____

Medication History

Do you take any medications? If yes, please, specify. (exclusion - intake of central nervous system-modulating medication) Yes
 No

Medication Classes : Exclusion Criteria

[Attachment: "incl_excl_dugs and drug classes.docx"]

Exclusion Drug Classes

[Inline Image: "Drug Class_TMS.png"]

Please list medications or supplements you are currently taking _____

Other Drug History

In the past 6 months how often have you used recreational drugs

- not at all
- rarely
- monthly
- weekly
- daily
- more than once per day
- other

TMS/ECT History

Have you ever had Transcranial Magnetic Stimulation (TMS)?

- Yes
- No

Please explain (research, treatment etc)?

Have you ever had an adverse reaction to transcranial magnetic stimulation (TMS)?

- Yes
- No

Please describe reaction

Enrollment

Was the research participant enrolled?

- Yes
- No

Reason not enrolled

Person reviewing enrollment criteria

- Catherine Ricciardi DNP, ANP
- Tatianna Urman, MSN, RN
- Dan Novy PhD (c)

End Screen enrollment

Instrumentation

Time Instrumentation begins

Preparation

-
- Inspect scalp
 - Insert Ear Plugs
 - Apply shoulder shield
 - Attach...
 - Confirm Helmet Placement
 - Confirm Comfort
 - Instructions
 - Ear plugs
 - Test noise of stimulation

Comments

Time Instrumentation Complete

Mood

Mood Assessment

- Pre Experiment
- Post Experiment
- Other

Other

Systolic BP

Diastolic

Pulse

Time Mood Assessment

Mood

	very	somewhat	neither happy or sad	not really	not at all
happy	<input type="checkbox"/>	<input type="checkbox"/>	<input type="checkbox"/>	<input type="checkbox"/>	<input type="checkbox"/>
sad	<input type="checkbox"/>	<input type="checkbox"/>	<input type="checkbox"/>	<input type="checkbox"/>	<input type="checkbox"/>
angry	<input type="checkbox"/>	<input type="checkbox"/>	<input type="checkbox"/>	<input type="checkbox"/>	<input type="checkbox"/>
anxious	<input type="checkbox"/>	<input type="checkbox"/>	<input type="checkbox"/>	<input type="checkbox"/>	<input type="checkbox"/>
scared	<input type="checkbox"/>	<input type="checkbox"/>	<input type="checkbox"/>	<input type="checkbox"/>	<input type="checkbox"/>
content	<input type="checkbox"/>	<input type="checkbox"/>	<input type="checkbox"/>	<input type="checkbox"/>	<input type="checkbox"/>

Comments

Side Effect Profile

PRE EXPERIMENT SYMPTOMS

Are the symptoms in matrix below PRE EXPERIMENT? Yes
 No

Time of pre-experiment symptom assessment _____

	Absent	Mild	Moderate	Severe
Headache	<input type="checkbox"/>	<input type="checkbox"/>	<input type="checkbox"/>	<input type="checkbox"/>
Neck Pain	<input type="checkbox"/>	<input type="checkbox"/>	<input type="checkbox"/>	<input type="checkbox"/>
Scalp Pain	<input type="checkbox"/>	<input type="checkbox"/>	<input type="checkbox"/>	<input type="checkbox"/>
Scalp irritation	<input type="checkbox"/>	<input type="checkbox"/>	<input type="checkbox"/>	<input type="checkbox"/>
Scalp Redness	<input type="checkbox"/>	<input type="checkbox"/>	<input type="checkbox"/>	<input type="checkbox"/>
Scalp sensation (tingling, itchy, burning, pain)	<input type="checkbox"/>	<input type="checkbox"/>	<input type="checkbox"/>	<input type="checkbox"/>
Scalp flakiness	<input type="checkbox"/>	<input type="checkbox"/>	<input type="checkbox"/>	<input type="checkbox"/>
Sleepiness	<input type="checkbox"/>	<input type="checkbox"/>	<input type="checkbox"/>	<input type="checkbox"/>
Trouble Concentrating	<input type="checkbox"/>	<input type="checkbox"/>	<input type="checkbox"/>	<input type="checkbox"/>
Other1	<input type="checkbox"/>	<input type="checkbox"/>	<input type="checkbox"/>	<input type="checkbox"/>
Other2	<input type="checkbox"/>	<input type="checkbox"/>	<input type="checkbox"/>	<input type="checkbox"/>

Other 1 _____

Other 2 _____

POST EXPERIMENT SYMPTOMS AND RELATIONSHIP TO TCS

Are the symptoms experienced in below matrix POST EXPERIMENT? Yes
 No

Time Post Experiment Symptom Assessment _____

POST EXPERIMENT SYMPTOMS

	Absent	Mild	Moderate	Severe	not related to TCS	Remote possibility related to TCS	Probably related to TCS	Definitely related to TCS
post Headache	<input type="checkbox"/>	<input type="checkbox"/>	<input type="checkbox"/>	<input type="checkbox"/>	<input type="checkbox"/>	<input type="checkbox"/>	<input type="checkbox"/>	<input type="checkbox"/>
post Neck Pain	<input type="checkbox"/>	<input type="checkbox"/>	<input type="checkbox"/>	<input type="checkbox"/>	<input type="checkbox"/>	<input type="checkbox"/>	<input type="checkbox"/>	<input type="checkbox"/>
post Scalp Pain	<input type="checkbox"/>	<input type="checkbox"/>	<input type="checkbox"/>	<input type="checkbox"/>	<input type="checkbox"/>	<input type="checkbox"/>	<input type="checkbox"/>	<input type="checkbox"/>
post Scalp Burns	<input type="checkbox"/>	<input type="checkbox"/>	<input type="checkbox"/>	<input type="checkbox"/>	<input type="checkbox"/>	<input type="checkbox"/>	<input type="checkbox"/>	<input type="checkbox"/>
post Sensations under electrodes	<input type="checkbox"/>	<input type="checkbox"/>	<input type="checkbox"/>	<input type="checkbox"/>	<input type="checkbox"/>	<input type="checkbox"/>	<input type="checkbox"/>	<input type="checkbox"/>
post Skin Redness	<input type="checkbox"/>	<input type="checkbox"/>	<input type="checkbox"/>	<input type="checkbox"/>	<input type="checkbox"/>	<input type="checkbox"/>	<input type="checkbox"/>	<input type="checkbox"/>
post Sleepiness	<input type="checkbox"/>	<input type="checkbox"/>	<input type="checkbox"/>	<input type="checkbox"/>	<input type="checkbox"/>	<input type="checkbox"/>	<input type="checkbox"/>	<input type="checkbox"/>
post Trouble Concentrating	<input type="checkbox"/>	<input type="checkbox"/>	<input type="checkbox"/>	<input type="checkbox"/>	<input type="checkbox"/>	<input type="checkbox"/>	<input type="checkbox"/>	<input type="checkbox"/>
Change in Mood	<input type="checkbox"/>	<input type="checkbox"/>	<input type="checkbox"/>	<input type="checkbox"/>	<input type="checkbox"/>	<input type="checkbox"/>	<input type="checkbox"/>	<input type="checkbox"/>
Other	<input type="checkbox"/>	<input type="checkbox"/>	<input type="checkbox"/>	<input type="checkbox"/>	<input type="checkbox"/>	<input type="checkbox"/>	<input type="checkbox"/>	<input type="checkbox"/>

If other

Comments

Threshold Titration

Head Circumference (cm) _____

Standard Measurement Head Circumference

[Inline Image: "head circumference SOP.png"]

Provide ear plugs Yes
 No

Provide instructions on countdown to stimulation and associated noise Yes
 No

Time Threshold _____

Threshold Matrix Max

Check only if positive response to stimulation to nearest stimulation

	white	red	green	blue	sham	sham1
1200 t	<input type="checkbox"/>	<input type="checkbox"/>	<input type="checkbox"/>	<input type="checkbox"/>	<input type="checkbox"/>	<input type="checkbox"/>
1300 t	<input type="checkbox"/>	<input type="checkbox"/>	<input type="checkbox"/>	<input type="checkbox"/>	<input type="checkbox"/>	<input type="checkbox"/>
1400 t	<input type="checkbox"/>	<input type="checkbox"/>	<input type="checkbox"/>	<input type="checkbox"/>	<input type="checkbox"/>	<input type="checkbox"/>
1440 t	<input type="checkbox"/>	<input type="checkbox"/>	<input type="checkbox"/>	<input type="checkbox"/>	<input type="checkbox"/>	<input type="checkbox"/>
1480 t	<input type="checkbox"/>	<input type="checkbox"/>	<input type="checkbox"/>	<input type="checkbox"/>	<input type="checkbox"/>	<input type="checkbox"/>
1500 t	<input type="checkbox"/>	<input type="checkbox"/>	<input type="checkbox"/>	<input type="checkbox"/>	<input type="checkbox"/>	<input type="checkbox"/>
1530 t	<input type="checkbox"/>	<input type="checkbox"/>	<input type="checkbox"/>	<input type="checkbox"/>	<input type="checkbox"/>	<input type="checkbox"/>
1560 t	<input type="checkbox"/>	<input type="checkbox"/>	<input type="checkbox"/>	<input type="checkbox"/>	<input type="checkbox"/>	<input type="checkbox"/>
1590 t	<input type="checkbox"/>	<input type="checkbox"/>	<input type="checkbox"/>	<input type="checkbox"/>	<input type="checkbox"/>	<input type="checkbox"/>
1600 t	<input type="checkbox"/>	<input type="checkbox"/>	<input type="checkbox"/>	<input type="checkbox"/>	<input type="checkbox"/>	<input type="checkbox"/>
1620	<input type="checkbox"/>	<input type="checkbox"/>	<input type="checkbox"/>	<input type="checkbox"/>	<input type="checkbox"/>	<input type="checkbox"/>
1650	<input type="checkbox"/>	<input type="checkbox"/>	<input type="checkbox"/>	<input type="checkbox"/>	<input type="checkbox"/>	<input type="checkbox"/>
1680	<input type="checkbox"/>	<input type="checkbox"/>	<input type="checkbox"/>	<input type="checkbox"/>	<input type="checkbox"/>	<input type="checkbox"/>
1700	<input type="checkbox"/>	<input type="checkbox"/>	<input type="checkbox"/>	<input type="checkbox"/>	<input type="checkbox"/>	<input type="checkbox"/>
1720	<input type="checkbox"/>	<input type="checkbox"/>	<input type="checkbox"/>	<input type="checkbox"/>	<input type="checkbox"/>	<input type="checkbox"/>
1750	<input type="checkbox"/>	<input type="checkbox"/>	<input type="checkbox"/>	<input type="checkbox"/>	<input type="checkbox"/>	<input type="checkbox"/>
1780	<input type="checkbox"/>	<input type="checkbox"/>	<input type="checkbox"/>	<input type="checkbox"/>	<input type="checkbox"/>	<input type="checkbox"/>
1800	<input type="checkbox"/>	<input type="checkbox"/>	<input type="checkbox"/>	<input type="checkbox"/>	<input type="checkbox"/>	<input type="checkbox"/>
1820	<input type="checkbox"/>	<input type="checkbox"/>	<input type="checkbox"/>	<input type="checkbox"/>	<input type="checkbox"/>	<input type="checkbox"/>
1840	<input type="checkbox"/>	<input type="checkbox"/>	<input type="checkbox"/>	<input type="checkbox"/>	<input type="checkbox"/>	<input type="checkbox"/>
1860	<input type="checkbox"/>	<input type="checkbox"/>	<input type="checkbox"/>	<input type="checkbox"/>	<input type="checkbox"/>	<input type="checkbox"/>
1880	<input type="checkbox"/>	<input type="checkbox"/>	<input type="checkbox"/>	<input type="checkbox"/>	<input type="checkbox"/>	<input type="checkbox"/>
1900	<input type="checkbox"/>	<input type="checkbox"/>	<input type="checkbox"/>	<input type="checkbox"/>	<input type="checkbox"/>	<input type="checkbox"/>
1920	<input type="checkbox"/>	<input type="checkbox"/>	<input type="checkbox"/>	<input type="checkbox"/>	<input type="checkbox"/>	<input type="checkbox"/>
1940	<input type="checkbox"/>	<input type="checkbox"/>	<input type="checkbox"/>	<input type="checkbox"/>	<input type="checkbox"/>	<input type="checkbox"/>
1960	<input type="checkbox"/>	<input type="checkbox"/>	<input type="checkbox"/>	<input type="checkbox"/>	<input type="checkbox"/>	<input type="checkbox"/>

1980	<input type="checkbox"/>	<input type="checkbox"/>	<input type="checkbox"/>	<input type="checkbox"/>	<input type="checkbox"/>	<input type="checkbox"/>
2000	<input type="checkbox"/>	<input type="checkbox"/>	<input type="checkbox"/>	<input type="checkbox"/>	<input type="checkbox"/>	<input type="checkbox"/>

Threshold found Yes
 No

Threshold _____

End Threshold _____

Comment _____

Experiment

Experiment Experiment 1 (isolation eyes closed)
 Experiment 2 (isolation eyes open)
 Experiment 3 (non isolation eyes closed)
 Experiment 4 (non isolation eyes open)
 Other

Other _____

Time Start _____

Threshold Voltage _____

	6-9 clock	3-6 clock	12-3 clock	9-12 clock	other
White	<input type="checkbox"/>	<input type="checkbox"/>	<input type="checkbox"/>	<input type="checkbox"/>	<input type="checkbox"/>
Red	<input type="checkbox"/>	<input type="checkbox"/>	<input type="checkbox"/>	<input type="checkbox"/>	<input type="checkbox"/>
Green	<input type="checkbox"/>	<input type="checkbox"/>	<input type="checkbox"/>	<input type="checkbox"/>	<input type="checkbox"/>
Blue	<input type="checkbox"/>	<input type="checkbox"/>	<input type="checkbox"/>	<input type="checkbox"/>	<input type="checkbox"/>
Sham1	<input type="checkbox"/>	<input type="checkbox"/>	<input type="checkbox"/>	<input type="checkbox"/>	<input type="checkbox"/>
Sham2	<input type="checkbox"/>	<input type="checkbox"/>	<input type="checkbox"/>	<input type="checkbox"/>	<input type="checkbox"/>

comments _____

placment2

	6-9 clock	3-6 clock	12-3 clock	9-12 clock	other
White2	<input type="checkbox"/>	<input type="checkbox"/>	<input type="checkbox"/>	<input type="checkbox"/>	<input type="checkbox"/>
Red2	<input type="checkbox"/>	<input type="checkbox"/>	<input type="checkbox"/>	<input type="checkbox"/>	<input type="checkbox"/>
Green2	<input type="checkbox"/>	<input type="checkbox"/>	<input type="checkbox"/>	<input type="checkbox"/>	<input type="checkbox"/>
Blue2	<input type="checkbox"/>	<input type="checkbox"/>	<input type="checkbox"/>	<input type="checkbox"/>	<input type="checkbox"/>
Sham(1)2	<input type="checkbox"/>	<input type="checkbox"/>	<input type="checkbox"/>	<input type="checkbox"/>	<input type="checkbox"/>
Sham(2)2	<input type="checkbox"/>	<input type="checkbox"/>	<input type="checkbox"/>	<input type="checkbox"/>	<input type="checkbox"/>

Comments _____

Number of Discharges Above Threshold _____
 (Plus/minus 120% of threshold)

Number of Discharges Correctly Placed _____

Number of Discharges Perceived But Incorrectly Placed _____

Number of Discharges Perceived _____

Number of False Positives _____
 (Did they see a sham?)

Number of False Negatives _____
 (They should have seen something but didn't.)

Time End _____

Time Total _____

Adverse Event Form

Name

Describe Adverse Event

COUHES AE FORM
Complete and Download

[Attachment: "AE Form-2019.doc"]

**CONSENT TO PARTICIPATE IN
BIOMEDICAL RESEARCH**

Transcranial Magnetic Evocation of Magnetophosphenes

Consent Form for Adult Volunteers

You are asked to participate in a research study conducted by Dr. V. Michael Bove and Daniel Novy from the Media Lab at the Massachusetts Institute of Technology (M.I.T.). You have been asked to participate in this study because you are a healthy adult. You should read the information below, and ask questions about anything you do not understand, before deciding whether or not to participate.

• **PARTICIPATION AND WITHDRAWAL**

Your participation in this research is completely VOLUNTARY. If you choose to participate you may subsequently withdraw from the study at any time without penalty or consequences of any

kind. If you choose not to participate, that will not affect your relationship with M.I.T. or your right to health care or other services to which you are otherwise entitled.

- **PURPOSE OF THE STUDY**

The purpose of this study is to test an innovative noninvasive brain stimulation technique. We specifically hope to evoke a perceivable phenomenon in the visual field. These improvements will have positive implications for understanding the function of the healthy human visual system and provide a foundation for the creation of a novel display technology.

- **PROCEDURES**

If you volunteer to participate in this study, we would ask you to attend up to two experimental sessions each lasting approximately 30 minutes. In these sessions we would ask you to do the following things:

Noninvasive brain stimulation:

We are interested in seeing if a device that we developed can create a perceivable phenomenon in the visual field. The device utilizes a technique called transcranial magnetic stimulation or (TMS).

TMS works as follows:

A helmet with insulated electromagnetic coils will be placed on your head.

An extremely brief electrical current will be passed through the coils.

The resulting brief magnetic field will stimulate your visual cortex.

The evoked response will or will not be visible in your visual field.

During the setup stage you will be seated in a chair in front of a screen or a wall. A member of the research team will place the helmet (insulated electromagnetic coils) on your head. These electromagnetic coils do not attach to your skin with a gel or paste in any way. A blindfold or other light-blocking device may be placed over your eyes. The electromagnetic coils are connected to the TMS device. Ear plugs will be offered and placed in your ears.

After the setup you will have a practice session to check if you experience any discomfort

from the TMS. We will generate a small current and ask you to report any sensation of light or skin tingling. We will start with minimum current level and will adjust it according to your feedback.

After the practice session, we will start the main experimental session in which we will apply current in short pulses at different power levels for up to 30 min in total and ask whether you see or do not see anything and if so, where it is. Although the currents are very brief, they may cause you to perceive light when there is not a light and/or possible muscle twitches. You may be asked to keep your eyes closed or open during certain pulses. The blindfold or other light-blocking device may or may not then be removed and the session repeated.

- **POTENTIAL RISKS AND DISCOMFORTS**

As a result of your participation in this study, you may experience side effects, this may include the ones listed below.

You should report immediately these side effects to the investigator.

TMS

More Common

TMS may feel like a sudden tap on the scalp accompanied by a clicking sound. TMS can cause face, neck or limb twitches. These twitches are generally not painful, but can feel odd or unpleasant when first experienced.

Neck Stiffness and Neck Pain

Neck stiffness and neck pain is believed to be due to the straight posture of the head and neck during the application of TMS. In the case of such an event, you will be offered acetaminophen (Tylenol) or aspirin which in most cases promptly resolves the discomfort. The experimental procedure will be immediately terminated if you report experiencing discomfort to the extent that they no longer wish to participate.

Loud Clicking Noise

TMS produces a loud clicking noise when the current passes through the coil. You will wear hearing protection in the form of ear plugs to protect your hearing during the session.

Less Common

Mild Headaches

Mild headaches are believed to be due to excessive muscle tension. In the case of a headache, you will be offered acetaminophen (Tylenol) or aspirin which in most cases promptly resolves the discomfort. The experimental procedure will be immediately terminated if you report experiencing a headache to the extent that you no longer wish to participate. The headaches are not recurring and subside following termination of the procedures.

Extremely Rare

Seizures

Risk of seizures in neurologically healthy subjects is low but not zero. Approximately eight instances of TMS-induced seizures occurring within the previous 20 years have been reported. Of the four in which TMS parameters were within previously set safety guidelines, three subjects were taking pro-epileptogenic medications (for which you should have been screened) and two of the instances may have represented non-epileptic events (i.e. syncope). Of four events with parameters outside the established safety guidelines, three of four instances of seizures occurred in patients taking pro-epileptogenic medications or following sleep-deprivation, and one of the four cases may have represented a non-epileptic event. These cases represent a very small fraction of tens of thousands of TMS participants.

IF YOU FEEL DISCOMFORT AT ANY TIME, NOTIFY THE OPERATOR AND
YOU CAN DISCONTINUE THE EXAM AT ANY TIME.

- **ANTICIPATED BENEFITS TO SUBJECTS**

You will not benefit from participating in this research.

- **ANTICIPATED BENEFITS TO SOCIETY**

If successful this study will provide an improved, lower-cost noninvasive brain stimulation device for research into creating a non-view blocking visual display device.

- **ALTERNATIVES TO PARTICIPATION**

Participation in this research is completely voluntary. The alternative to participating in the study is to not participate. What this means is that you can decide not to participate in the experiment. There is no penalty or consequence to withdrawing before or during the study.

- **PAYMENT FOR PARTICIPATION**

You will not be paid for your participation.

- **FINANCIAL OBLIGATION**

Neither you nor your insurance company will be billed for your participation in this research.

- **PRIVACY AND CONFIDENTIALITY**

The only people who will know that you are a research subject are members of the research team and, if appropriate, your physicians and nurses. No information about you, or provided by you during the research will be disclosed to others without your written permission, except: if necessary to protect your rights or welfare, or if required by law. In addition, your information may be reviewed by authorized MIT representatives to ensure compliance with MIT policies and procedures.

When the results of the research are published or discussed in conferences, no information will be included that would reveal your identity. No photographs, videos, or audio-tape recordings of you will be collected.

- **CONSEQUENCES OF WITHDRAWAL**

There is no consequence to withdrawing from the research study at any time, before or during the study.

- **WITHDRAWAL OF PARTICIPATION BY THE INVESTIGATOR**

The investigator may withdraw you from participating in this research if circumstances arise which warrant doing so. If you experience any of the following side effects: strong pain or if you become ill during the research, you may have to drop out, even if you would like to continue.

The investigator, Daniel Novy, will make the decision and let you know if it is not possible for you to continue. The decision may be made either to protect your health and safety, or because it is part of the research plan that people who develop certain conditions may not continue to participate.

- **NEW FINDINGS**

During the course of the study, you will be informed of any significant new findings (either good or bad), such as changes in the risks or benefits resulting from participation in the research or new alternatives to participation, that might cause you to change your mind about continuing in the study. If new information is provided to you, your consent to continue participating in this study will be re-obtained.

- **EMERGENCY CARE AND COMPENSATION FOR INJURY**

If you feel you have suffered an injury, which may include emotional trauma, as a result of participating in this study, please contact the person in charge of the study as soon as possible.

In the event you suffer such an injury, M.I.T. may provide itself, or arrange for the provision of, emergency transport or medical treatment, including emergency treatment and follow-up care, as needed, or reimbursement for such medical services. M.I.T. does not provide any other form of compensation for injury. In any case, neither the offer to provide medical assistance, nor the actual provision of medical services shall be considered an admission of fault or acceptance of liability. Questions regarding this policy may be directed to MIT's Insurance Office, (617) 253-2823. Your insurance carrier may be billed for the cost of emergency transport or medical treatment, if such services are determined not to be directly related to your participation in this study.

- **IDENTIFICATION OF INVESTIGATORS**

In the event of a research related injury or if you experience an adverse reaction, please immediately contact one of the investigators listed below. If you have any questions about the research, please feel free to contact the investigators:

1. V. Michael Bove., Principal Investigator vmb@media.mit.edu
2. Daniel Novy novysan@media.mit.edu, 310-482-1725

- **RIGHTS OF RESEARCH SUBJECTS**

You are not waiving any legal claims, rights or remedies because of your participation in this research study. If you feel you have been treated unfairly, or you have questions regarding your rights as a research subject, you may contact the Chairman of the Committee on the Use of Humans as Experimental Subjects, M.I.T., Room E25-143B, 77 Massachusetts Ave, Cambridge, MA 02139, phone 1-617-253 6787.

SIGNATURE OF RESEARCH SUBJECT OR LEGAL REPRESENTATIVE

I have read (or someone has read to me) the information provided above. I have been given an opportunity to ask questions and all of my questions have been answered to my satisfaction. I have been given a copy of this form.

BY SIGNING THIS FORM, I WILLINGLY AGREE TO PARTICIPATE IN THE RESEARCH IT DESCRIBES.

Name of Subject

Name of Legal Representative (if applicable)

Signature of Subject or Legal Representative

Date

SIGNATURE OF PERSON OBTAINING INFORMED CONSENT

I have explained the research to the subject or his/her legal representative, and answered all of his/her questions. I believe that he/she understands the information described in this document and freely consents to participate.

Name of Person Obtaining Informed Consent

Signature of Person Obtaining Informed Consent Date (must be the same as subject's)

SIGNATURE OF WITNESS (If required by COUHES)

My signature as witness certified that the subject or his/her legal representative signed this consent form in my presence as his/her voluntary act and deed.

Name of Witness
